

MHHS Programme

Environment Approach & Plan

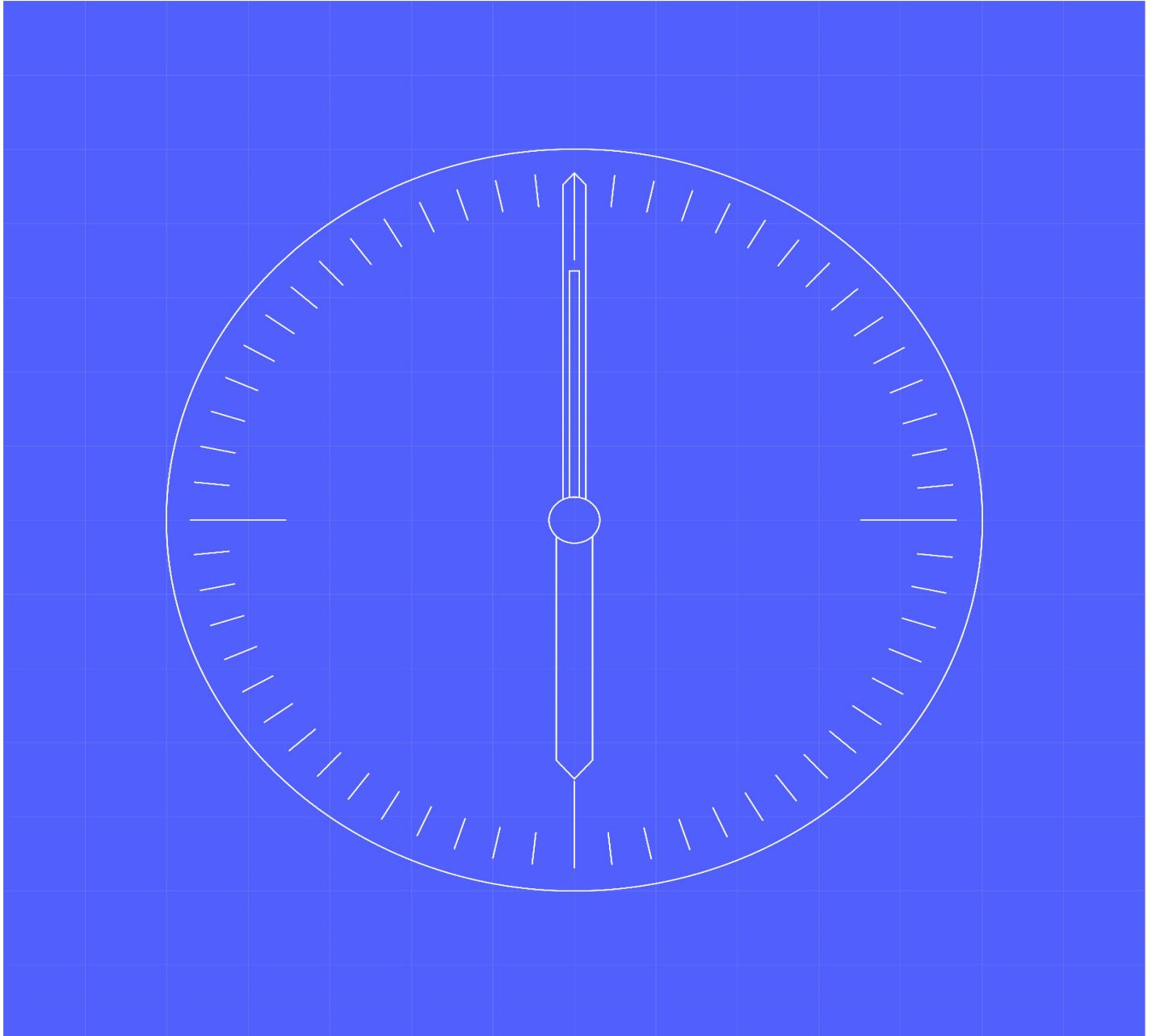

Document owner

Simon Berry

Status:

Draft

Document number

MHHS-DEL618

Date

15 November 2023

Version

2.9

Classification

Public

1. Contents

1.	Contents	1
1.1	Change Record	5
1.2	Reviewers	5
1.3	Document References	6
1.4	Terminology	6
2	Executive Summary	7
3	Introduction	8
3.1	Document Purpose	8
3.2	Reviews and Approvals	8
3.3	Change Forecast	9
3.4	Summary of Changes	9
4	Objectives	10
4.1	Key Points	10
4.2	Assumptions and Caveats	10
4.3	Environment Working Group (EWG)	10
5	Scope	11
5.1	Out of Scope	11
5.2	Environment Managers	11
5.3	Participants	11
5.4	Test Phases	11
5.5	Coordination and Planning	12
5.6	Maintenance, Availability and Monitoring	12
6	Governance	13
6.1	Meetings	13
6.2	Mail and Mail Groups	13
6.3	SIT	13
6.4	UIT	13
7	Environment Requirements	14
7.1	Environment Allocation	14
7.1.1	Scheduling	14
7.1.2	SIT	15
7.1.3	UIT	16
7.1.4	Pre-Prod and Production	16
7.2	Test Data and Configuration	16
7.2.1	Reference and Business Data	16
7.2.2	SIT	17
7.2.3	UIT	17
7.3	Configuration	18
8	Testing Participants	19

8.1	High Level View of participants	19
8.2	Central Parties / Core Solutions Provider Overview	20
8.3	Data Integrations Service Provider (Avanade)	20
8.4	Elexon Central Systems	20
8.5	Data Communications Company (DCC)	20
8.5.1	DCC – DSP	20
8.5.2	DCC – CSS	20
8.6	Retail Energy Code Company	21
8.7	Electralink – Data Transfer Network (DTN)	21
8.8	St. Clements – MPRS	21
8.9	(I)DNOs’ Environments	21
8.10	Suppliers and Agents Environments	21
9	Overall Test Environment Architecture by Test Phase/Stage	22
9.1	MHHS Programme Target Operating Model Architecture diagram	22
9.2	MHHS Programme Test Environment	23
9.3	SIT – Component Integration Test	23
9.3.1	DIP Test Environment	24
9.3.2	Elexon (Helix)	24
9.3.3	Recco	25
9.3.4	St. Clements	26
9.3.5	DCC	26
9.3.6	Electralink	26
9.4	SIT Functional Testing	27
9.4.1	Avanade - DIP	27
9.4.2	DCC	28
9.4.3	Electralink	29
9.4.4	Elexon (Helix)	35
9.4.5	Recco	36
9.4.6	St. Clements	37
9.5	SIT Non-Functional Testing	37
9.6	Non-SIT LDSO Qualification Testing	37
9.7	Qualification / Sandbox	38
9.8	Staging Environments	38
9.8.1	Avanade	38
9.8.2	DCC	38
9.8.3	Electralink	38
9.8.4	Elexon / Helix	38
9.8.5	Recco	39
9.8.6	St. Clements	39
10	Connecting to the DIP	40
10.1	DIP Onboarding	40
10.2	Code of Connection	40

10.2.1	Registration Responsibilities	41
10.2.2	PKI Certificate Expiry	41
10.2.3	Certificates by Environment	41
10.3	Non-DIP connections	42
10.3.1	Connecting to the DCC Test Environment	42
10.3.2	Connecting to Helix PMP	43
11	Test Phases and Concurrent Environment Requirements	44
11.1	High Level MHHS Test POAP	44
11.2	MHHS Environments Timeline	45
11.2.1	Non-SIT LDSO Qualification Testing Environments timeline	45
11.3	CIT Connectivity Proving	46
11.3.1	External Connectivity	47
11.3.2	Internal Connectivity	47
11.4	SIT Functional Test Connectivity Proving	47
11.5	Environment Availability Requirements	48
12	Test Execution	49
12.1	Planning	49
12.1.1	Tracking and Coordination	49
12.1.2	SIT	49
12.1.3	UIT	50
12.2	Assurance and Readiness Criteria	50
12.3	Communications and Meetings	51
12.3.1	Mail and Mail Groups	51
12.3.2	Meetings	51
12.4	Monitoring	52
12.4.1	Manual Monitoring	52
12.5	Availability	52
12.5.1	Central Systems Unavailability	52
12.5.2	Test Participant Systems Unavailability	53
12.5.3	Unavailability and mitigation	53
12.6	Maintenance	53
12.7	Central Parties / Core Solutions Provider Test Environment Availability, Monitoring and Back-ups	54
12.7.1	DIP	54
12.7.2	Elexon (Helix)	54
12.7.3	Recco	54
12.7.4	St. Clements	55
12.7.5	DCC	55
12.8	Programme Participants Data Back-ups	55
12.8.1	Frequency and timing of Data Back-up	55
12.8.2	Nature of Back-up	55
12.8.3	Restore from Back-up	55
13	Roles and Responsibilities	56

13.1	Environment Managers	56
13.2	Programme Responsibilities	56
14	Content Outstanding	59

Tables

Table 1 - MHHS Test Environments	14
Table 2 - High Level View of participants	19
Table 3 - Central Parties / Core Solutions Provider Overview	20
Table 4 - Environment Availability Requirements	48
Table 5 - DIP Environment Availability, Monitoring and Back ups	54
Table 6 - Elexon (Helix) Environment Availability, Monitoring and Back ups	54
Table 7 - Recco Environment Availability, Monitoring and Back ups	54
Table 8 - St. Clements Environment Availability, Monitoring and Back ups	55
Table 9 - DCC Environment Availability, Monitoring and Back-ups	55
Table 10 - Roles and Responsibilities	58

Figures

Figure 1 - Target Operating Model	22
Figure 2 - CIT Market Role interactions	23
Figure 3 - DIP Test Environment	24
Figure 4 - Elexon (Helix) Test Environment	24
Figure 5 - Recco Test Environment	25
Figure 6 - St. Clements Test Environment	26
Figure 7 Avanade SIT Functional Test Environment Architecture	27
Figure 8 DCC UIT-B Test Environment Architecture	28
Figure 9 DTN D-Flows in scope for SIT Functional Testing	29
Figure 10 Supplier D-Flows	30
Figure 11 ADS D-Flows	31
Figure 12 SDS D-Flows	31
Figure 13 MSA D-Flows	32
Figure 14 MSS D-Flows	32
Figure 15 LDSO D-Flows	33
Figure 16 UMSSO D-Flows	33
Figure 17 UMSSDS D-Flows	33
Figure 18 Helix D-Flows	34
Figure 19 Helix SIT Functional Test Environment Architecture	35
Figure 20 Recco SIT Functional Test Environment Architecture	36
Figure 21 St. Clements SIT Functional Test Environment Architecture	37
Figure 22 - High Level MHHS Test POAP	44
Figure 23 - MHHS Environments Timeline	45
Figure 24 - Scope of CIT Connectivity Proving	46
Figure 25 - Roadmap for sign-off of the Environments Approach & Plan - dependencies	59

1.1 Change Record

Date	Author(s)	Version	Change Detail
08 Aug 2022	Adrian Samlal	0.1	Initial Draft for LDP peer review
30 Aug 2022	Adrian Samlal	0.2	First round review LDP updates
08 Sept 2022	Adrian Samlal	0.3	Minor updates
30 Sept 2022	Adrian Samlal	0.4	SRO review updates
03 Oct 2022	Adrian Samlal	1.0	Document with updates ready for participant distribution
21 Oct 2022	Adrian Samlal	2.0	Participant feedback addressed
07 Nov 2022	Adrian Samlal	2.1	Caveats added to Executive Summary and Section 10
16 Jan 2023	Simon Berry	2.2	New Section 9, Test Phases and Concurrent Environment Requirements added. Section 10. Added Test Environment End to End Overview. Section 11. Added the Environment Details Template.
03 July 2023	Simon Berry	2.3	Restructure of the document. New sections added. Detailed change log included in the associated spreadsheet. Draft for SRO review
07 July 2023	Simon Berry	2.4	Draft for Programme Participant review
21 July 2023	Simon Berry	2.5	Approved version following Programme Participant review
09 October 2023	Simon Berry	2.6	Updated version for SRO review. Changes include; Programme Participants Environment Back-ups, CIT Connectivity Proving, Helix PMP Onboarding, DCC Onboarding, SIT Functional Environment Architecture, DTN D-Flows by Market Role. Draft for SRO review.
13 October	Simon Berry	2.7	Draft for Programme Participant review
30 October	Simon Berry	2.8	Amendments following Programme Participant review.
15 November	Simon Berry	2.9	Amendment to section 11.3.1.3

1.2 Reviewers

Reviewer	Role
Adrian Page	LDP SI Workstream Lead
Kevin Davis	LDP Test Architect
Paul Pettitt	LDP Design Lead
Lee Cox	LDP SI Test Team
Dominic Mooney	LDP SI Test Team
Adrian Ackroyd	SRO Function Programme Test Manager
Smitha Pichrikat	SRO Function Client Delivery Manager

1.3 Document References

Ref No.	Document/Link	Publisher	Published	Additional Information
REF-01	MHHS -DEL 315 E2E Testing & Integration Strategy	SI Testing	29 th April, 2022	
REF-02	MHHS-DEL172 Change Control Approach	PMO	6 th August, 2022	
REF-03	MHHS-DEL030 Programme Governance Framework	PMO	08 th March, 2023	
REF-04	MHHS-DEL813 Overarching Test Data Approach & Plan	SI Testing	5 th July, 2023	
REF-05	MHHS-DEL466 Defect Management Plan	SI Testing	23 rd May, 2023	
REF-06	MHHS-DEL1197 - Interface Code of Connection	DAG	15 th September, 2023	
REF-07	MHHS-DEL1089 Release and Configuration Approach & Plan	SI	17 th May, 2023	
REF-08	MHHS-DEL1118 Qualification Approach & Plan	Code Bodies	30 th May, 2023	
REF-09	MHHS DEL-1064 Placing Reliance Policy	SI	27 th April, 2023	
REF-10	MHHS DEL1671 DIP Onboarding Guide	MHHS	3 rd October, 2023	
REF-11	MHHS-DES196 - D-Flow and Interface Mapping	MHHS	10 th October, 2023	

1.4 Terminology

Term	Description
Various	For terminology, see Programme Glossary on the MHHS portal: Programme Glossary (SharePoint.com)

2 Executive Summary

The Market-wide Half Hourly Settlement programme (MHHS) when completed will contribute to a more cost-effective electricity system, encouraging more flexible use of energy and helping consumers lower their bills. The responsibility for success is shared between all parties and stakeholders, with everyone working together to make sure the programme is delivered and in the highest possible quality.

Robust quality assurance for the necessary changes is required for this complex programme, not least during the industry testing stages where proactive and efficient management of system environments will be crucial to the overall success of the programme objectives. This document provides definition to MHHS Industry Test participants on the approach for testing environments covering planning, scheduling, management, coordination, readiness, and maintenance. The approach and process adopted is intended to be familiar for those industry test participants involved in recent industry programmes.

This document will go through subsequent iterations. It has been agreed with the Environment Working Group (EWG) that version 2.1 is recommended to the Testing Migration Advisory Group (TMAG) as an approved draft with the expectation of future updates on dependent information or where updates are required on artefacts that the document references.

This document has a dependency on the baselining of the MHHS Programme Plan and the development of the SIT and Qualification approaches and plans being developed in the SITWG and QWG. In addition the Migration, Non-Functional and Data approaches and plans are being developed in the MWG, NFTWG and DWG. Until all of these approaches and plans have been fully formed this document has to be considered a living document.

3 Introduction

3.1 Document Purpose

This document intends to set out detailed guidance and requirements for the use and provision of testing environments during the MHHS Programme preparation and test phases. It provides clear guidance in terms of the approach and planning for the intended Test Participants (TPs).

This document should be read by the following groups:

- MHHS Test Participants engaged in MHHS programme design, build and industry testing activities
- SRO Function (SRO)
- Lead Delivery Partner (LDP)
- Core Programme Team (CPT)
- System Integration Team (SI)
- Programme Party Coordinator (PPC)
- Programme Management Office (PMO)
- Testing and Migration Advisory Group (TMAG)
- Environment Working Group (EWG)
- Independent Programme Assurance (IPA)
- DIP Service Provider
- Code Bodies.

3.2 Reviews and Approvals

The document will be reviewed by the following team members:

- Kevin Davis, LDP Test Architect
- Lee Cox, LDP SI Test Team
- Dominic Mooney, LDP SI Test Team.

Upon completion of LDP/Expleo review, it will then go through a formal SRO team review by:

- Adrian Ackroyd, SRO Function Programme Test Manager
- Smitha Pichrikat, SRO Function Client Delivery Manager

Upon completion of the SRO review it will then be distributed to the EWG for review where comments will be incorporated leading to a recommendation of approval by the group.

When comments and feedback have been incorporated, approval will be requested from:

- Testing and Migration Advisory Group (TMAG).

The document will also be reviewed by Programme Participants before submitting to the TMAG and will be made available for information via the programme portal.

3.3 Change Forecast

This document will be reviewed and where applicable, updated when the following are available or updated:

- Baselined E2E MHHS Design
- Re-baselined MHHS Programme Plan
- MHHS Overarching Test Data Approach Plan
- DIP Design implementation.

The SI Test Team will own this document and maintain it, with review and approval by MHHS programme governance as appropriate. Each new version supersedes the previous version in its entirety. It will follow the Programme's change control process governed by the PMO [\[REF 02\] MHHS-DEL171 Change Control Approach](#).

Updates to this document will follow the review and approval process outlined in section 3.2.

3.4 Summary of Changes

This is version 2.8 that has had quality checks performed. Please refer to section 1.1, Change Record for a list of changes, or refer to a redlined version of this document.

4 Objectives

4.1 Key Points

The Environment Approach & Plan aims to clarify the following:

- Management and tracking environment builds.
- Planning and allocation in the use of environments for relevant participants, including user access permissions and control.
- Maintenance, availability, and monitoring of environments, including the specification of back-ups, exports, refreshes, or roll backs.
- Tracking and coordination in resolving environment issues using the defect management workflow.
- Considering the environment requirements for the various stages within the SIT and UIT phases.

The process and mechanisms within this document fully support the underlying principles described in [REF-01 MHHS E2E Testing & Integration Strategy].

4.2 Assumptions and Caveats

This document is written to aid strategy and planning for test environments. However, there are certain caveats which will hinder early versions of this document due to the unavailability of key information. Therefore, the intention is to add more detailed information as when this information becomes available. This should not impact approval of the initial publication of this document where the assumption is that approval is based on the intended content.

Key information include:

- Baseline dates and guidance of the programme.

4.3 Environment Working Group (EWG)

- The MHHS Environment Manager will work with the EWG to initially shape the Environment Approach & Plan. The MHHS Environment Manager is responsible for tracking initial plans for building each environment, identifying environment owners of each participant, the method for environment deployment and usage, and strategy for maintenance and issue resolution. Where appropriate, the MHHS Environment manager will report these activities back to the EWG, Programme Participants and Stakeholders.
- The EWG will report their output to the TMAG for approval. This will occur on an ongoing basis and may require engagement with other programme participants. Where the EWG is unable to reach a consensus on a decision delegated to them by TMAG the matter will be escalated to the TMAG.

5 Scope

5.1 Out of Scope

- Configuration – This will briefly be outlined in this document where it relates to infrastructure such as internal and external DNS service names. A separate in-depth document will be created, entitled [REF-07] Release and Configuration Approach & Plan, which will hold more detailed info on release processes and technical configuration.
- PIT – responsibility of Test Participants to perform their own tests on their own environments before SIT. The SI Test Team will provide the simulator to be used by Test Participants during their PIT.

5.2 Environment Managers

Environment managers play a key role in ensuring test environments operate successfully. The scope of this document will try to address the expectations for members of the Environment Working Group (EWG) and that of environment managers.

These will be covered comprehensively in Section 13, Roles and Responsibilities.

5.3 Participants

All Test Participants involved in MHHS testing will be expected to comply with the Environment Approach & Plan.

These are:

- Suppliers
- Service providers
- (I)DNOs
- Data Integration Platform service provider (responsible for the DIP)
- DCC (responsible for both Smart Metering and Central Switching Service)
- Elexon (responsible for Elexon Central Systems, which comprise Load Shaping Service, Market Data Service, Volume Allocation Service, Industry Standing Data Service and BSC Settlement Operations)
- Electralink (responsible for the Data Transfer Network – DTN)
- St Clements and C&C, together with the (I)DNOs (responsible for SMRS)
- UMISOs (responsible for the UMISO services)
- RECCo (responsible for EES).

Each of the parties above is referred to as a Test Participant (TP) throughout this document.

5.4 Test Phases

There are various test phases which determine how and when Test Participants use environments. These test phases will be referred to throughout the document and can be referenced in the [REF-01] MHHS-DEL315 E2E Testing and Integration Strategy document. The SI Test Team will schedule the test phases and work with the MHHS Environment Manager for environment coordination and planning.

5.5 Coordination and Planning

Planning and scheduling of testing for each Test Participant will be outlined in the Programmes central test plans. This will align with the scheduling for using the test environments.

5.6 Maintenance, Availability and Monitoring

Specific areas that cover maintenance, environment availability and monitoring are covered. Maintenance will describe reasons where environment maintenance may occur with the intention of referencing a log where this information is held. Environment availability will have the same intention covering where intended and non-intended reasons for times when environments are not available. Monitoring will cover the type of intended tooling that will be used to ensure environment availability and alert when environments become unavailable.

6 Governance

6.1 Meetings

Regular meetings will take place and will focus on members of the Environment Working Group (EWG) and those with specific interests in the preparation and status of the test environments. Meetings will take the form of the following:

- Monthly EWG catch up will occur on the first Tuesday of every month. This is an open forum which all Programme Participants and interested parties are encouraged to attend. It will cover open topics, key points over the past and upcoming monthly period, and any general queries that the group may have.
- If Programme Participants are interested in joining the Environments Working Group or any other Working Group please contact the MHHS PMO at the following mailbox; PMO@mhhsprogramme.co.uk

6.2 Mail and Mail Groups

- EWG members will be part of the EWG mailing list for the monthly meetings.
- As the Programme proceeds a separate mailbox *may* be created for environment queries and mailings.
- As the Programme proceeds an MS Teams channel *may* be setup to service immediate queries.

6.3 SIT

- Environment managers / representatives involved in SIT will be expected to attend regular meetings related to environments and the EWG. The frequency of these meetings is dependent on the criticality of project deliverables and issues. This could involve daily stand ups and weekly meetings based on testing schedules. Any ad-hoc meetings outside of the regular EWG meetings are likely to be relevant to Test Participants involved in test execution or where issues may occur that impacts testing. In these circumstances, only those involved in testing need to attend. Meetings will currently cover requirements from now until SIT and subsequently, planning and execution.

6.4 UIT

- All participants involved in UIT (Qualification and E2E Sandbox testing if applicable) should attend regular meetings related to environments and the EWG. Frequency dependent on the criticality of project deliverables and issues. This could involve daily stand ups and weekly meetings based on testing schedules. Meetings will cover planning and execution for UIT.

7 Environment Requirements

7.1 Environment Allocation

7.1.1 Scheduling

Test Participants must have an allocated Environment Manager or nominate a similar representative to ensure scheduling is performed smoothly. Failure to do this can create conflicts in testing requirements and ensures approved code versions are used when testing is performed on test environments.

The following table is the assumed usage strategy for each Central System environment required for test phases. The actual timelines will be agreed with the Programme and a reference will be added here when that is available:

Environment	Phase	Testing Stage	Comments
SIT Staging			Readiness for SIT such as regression for changes, defect re-testing, etc. This will ensure that the actual SIT environments are not broken when new code is deployed.
SIT A	SIT	SIT Component Integration SIT Functional	Component integration tests will be conducted as individual components are integrated. Then full end-to-end testing can start.
SIT B	SIT	SIT Migration SIT Non-Functional* SIT Operational	It is assumed these three stages can be executed on one environment, but not in parallel to avoid conflicts. Test Participants can decide to have their own environment for each stage or re-purpose their environments for each stage. *Note new systems, such as the DIP, <i>may</i> be required to run tests on Pre-Prod and Prod.
UIT	UIT	Qualification E2E Sandbox	Central systems and some (I)DNOs' environments (most likely as a test harness / stub in the case of (I)DNOs) will be provided as a testing service to allow Test Participants to conduct Qualification Testing and E2E Sandbox Testing. Each Test Participant will need to complete either SIT or Qualification Testing before starting E2E Sandbox Testing.

Table 1 - MHHS Test Environments

Note: [Section 8.1](#) contains an overview of participants.

7.1.2 SIT

- SI will specify the necessary environments for the central systems and monitoring progress on their delivery.
- Environment coordination will be managed by the MHHS Environment Manager.
- Test Participants involved in SIT will have timeframes planned into testing schedules with advanced notice being given. This is to avoid clashes in testing requirements and ensures approved code versions are used.
- Parties taking part in SIT will need to provide their own system test environments for:
 - SIT Functional
 - SIT Non-Functional and Migration
- To plan appropriately, the following information *may* be needed
 - Reference Data requirements will be coordinated with the Test Data Manager with advanced notice in line with testing schedules. Test Participants will also be expected to attend regular planning meetings. This will give the Test Data Manager enough time to prepare data requirements and to allow Test Participants sufficient time to prepare their activities.
 - The SI Test Team will schedule the usage of the test environments (which will be shared across the programme) according to the testing plan. The MHHS Environment Manager will hold a centralised version of the plan which will be reviewed on a regular basis.
- Environment coordination will be managed by the MHHS Environment Manager.
- Test Participants not involved in SIT will need to participate in the UIT Qualification test phase and will need appropriate slots on the associated environment to be planned in by the SI Test Team and MHHS Environment Manager, in collaboration with the Code Bodies.
- Number of SIT environments required will be determined by the SI Test Team and feasibility will be discussed with the EWG. Currently two SIT environments are envisaged.
 - One environment for component integration, functional testing.
 - One environment for non-functional, migration and operational testing. Whilst test phases run in parallel the assumption is that test scheduling will allow a single environment can be used for all 3 phases.
- A Change Request and approval will be needed from the Programme if more SIT environments are required.

7.1.3 UIT

- SI Test Team will specify the necessary environments for the central systems and monitoring progress on their delivery.
- Parties taking part in UIT Qualification will need to provide their own system test environments for the test phase.
- Environment coordination will be managed by the MHHS Environment Manager.
- Qualification
 - The Code Bodies will allocate tranches for Test Participants to perform testing. Please refer to [REF 08 MHHS-DEL1118 Qualification Approach & Plan] for details regarding Qualification.
 - Test Participants must provide their own environment and connection details to connect to central systems.
 - SI Test Team will make available configuration details of central systems for connection.
 - Test Participants not involved in SIT will need to pass Qualification testing and hence will need to use the Qualification Environment. Test Participants that have been involved in SIT may need to participate in Qualification Testing if they have Market Roles that were not tested in SIT or if any of the Market Roles that they did test in SIT have different technology architectures to those tested in SIT. Please refer to [REF 08 MHHS-DEL1118 Qualification Approach & Plan] for details regarding Qualification.
- E2E Sandbox
 - SI Test Team and Code Bodies will most likely allocate tranches for Test Participants to perform testing.
 - Test Participants must provide their own environment and connection details to connect to central systems.
 - SI Test Team will make available configuration details of central systems for connection.
 - Test Participants that qualify by passing SIT may perform testing on the E2E Sandbox environment if they require.

7.1.4 Pre-Prod and Production

The SI Test Team will coordinate the roadmap to production readiness. However, it is expected that participants will have their own Pre-Production and Production environments in line with their own strategies.

Programme Participants are also expected to have their own Service Management model in place.

7.2 Test Data and Configuration

7.2.1 Reference and Business Data

Data in environments comes under two categories:

- Reference – static data that is part of the environment set up.
- Business – specific data used in user testing scenarios to sign off functionality.

The EWG will work closely with the Data Working Group (DWG) to ensure correct data is set up in the environments. This will be in line with the [REF-04] Test Data Strategy and Test Data Overarching Approach & Plan. Test Participants are also recommended to join the DWG for specific questions around data.

The SI will undertake coordination for all data set-up.

7.2.2 SIT

- The Data Working Group (DWG) will coordinate data requirements. Participant infrastructure build teams will load data with the SI Test Data Manager coordinating.
- Test Participants will be required to load the Industry Standing Data prior to commencement of testing. Details will be provided via the Data Working Group and other communications from the Data Workstream.
- Test Participants need to ensure the correct data requirements are confirmed prior to testing in relation to the testing schedule.
- Test Participants will need to ensure their own data migration or ETL processes are in place to load their own business data.
- Business data integrity checks *may* be specified for SIT by the SI Test Data Manager, which Test Participants would need to execute.

7.2.3 UIT

- The Data Working Group (DWG) will coordinate data requirements. Participant infrastructure build teams will load data with the SI Test Data Manager coordinating.
- Test Participants will be required to load the Industry Standing Data prior to commencement of testing. Details will be provided via the Data Working Group and other communications from the Data Workstream.
- Test Participants need to ensure the correct data requirements are confirmed prior to testing in relation to the testing schedule.
- Test Participants will need to ensure their own data migration or ETL processes are in place to load their own business data.
- Business data integrity checks *may* be specified for SIT by the SI Test Data Manager, which Test Participants would need to execute.

Test data requirements for Qualification are not being defined at present.

7.3 Configuration

Configuration (including Release Management) will be covered in detail in the [REF-07] Release and Configuration Approach & Plan. However, as this is closely connected to this document an outline below will highlight the areas of coverage:

- Environment Builds – plan of the test environments including services, components, and their versions.
- Deployments – detail for deploying a version of software into an environment and how that will be communicated.
- Release Roadmap – plan demonstrating the central system timelines for software releases.
- Configuration – connection details for TPs to connect their own systems to central systems.
- Version Control – details on how the versions of the DIP are kept up to date for each release.
- Backups – detailing process and frequency of backing up the environment including copies of data and configs.
- Exports - detailing process and frequency of backing up the environment including copies of data and configs.
- Refreshes - detailing process and plan for data refreshes.
- Rollbacks – documenting the process to roll back the environment to a previous version.
- Release Notes and testing impact assessment – structure of the release notes including the process for assessing any impacts on the current environment functionality.
- Business data loading – documenting the process to load business data.

8 Testing Participants

The tables in this section shows each participant type and the environments needed for testing for each testing phase. The tables will be updated in later versions of this document when re-planning is complete, and Test Participants have confirmed their testing approach.

8.1 High Level View of participants

The Table 2 is based on the [REF-01] MHHS DEL 315 E2E Testing & Integration Strategy demonstrating the environments required for the phases of testing.

Table 2 provides a view of environments that will be provided by participants and currently demonstrates assumptions.

The environment requirements for SIT A (SIT Functional) are stated throughout this document. The environment requirements for SIT B (SIT non-Functional) and UIT / Qualification have yet to be defined in detail, and will be included in future iterations of this document. Discussions are ongoing within the MHHS Programme to determine the approach for non-SIT LDSO Qualification Testing and Qualification Testing and there is potential for test stubs to be used for some Market Roles.

BSC Role	Responsible Organisation(s)	MHHS Test Environments			
		SIT-Staging	SIT A	SIT B	UIT
MSS (Metering Service Smart)	service provider	N/A	Y (selected)	Y (selected)	Y
SDS (Smart/Non-Smart Data Service)	service provider	N/A	Y (selected)	Y (selected)	Y
MSA (Metering Service Advanced)	service provider	N/A	Y (selected)	Y (selected)	Y
ADS (Advanced Data Service)	service provider	N/A	Y (selected)	Y (selected)	Y
UMSDS (UMS Data Service)	service provider	N/A	Y (selected)	Y (selected)	Y
DC (Data Collector)	agent	N/A	-	Y (selected)	tba
DA (Data Aggregator)	agent	N/A	-	Y (selected)	tba
MOP (Meter Operator)	agent	N/A	-	Y (selected)	tba
domestic supplier	supplier	N/A	Y (selected)	Y (selected)	Y
non-domestic supplier	supplier	N/A	Y (selected)	Y (selected)	Y
DSP	DCC	Y	Y	Y	Y (service)
CSS	DCC	Y	Y	Y	Y (service)
EES	RECCo	Y	Y	Y	Y (service)
ISDS (Industry Standing Data Service)	Elexon	Y	Y	Y	Y (service)
LSS (Load Shaping Service)	Elexon	Y	Y	Y	Y (service)
MDS (Market-wide Data Service)	Elexon	Y	Y	Y	Y (service)
VAS (Volume Allocation Service)	Elexon	Y	Y	Y	Y (service)
Settlement Operations	Elexon	Y	Y	Y	Y (service)
Existing Settlement Operation (Non-MHHS)	Elexon	Y	TBD	TBD	TBD
UMSO	(I)DNOs	N/A	Y (selected)	Y (selected)	Y
Network Operations	(I)DNOs	N/A	Y (selected)	Y (selected)	Y
Registration Services	(I)DNOs	Y	Y (selected)	Y (selected)	Y
DIP	MHHS	Y	Y	Y	Y (service)
DTN	Electralink	N/A	Y	Y	Y (service)

Table 2 - High Level View of participants

For details of Central Parties and Core Solutions Provider Staging Environments please refer to section 9.8.

8.2 Central Parties / Core Solutions Provider Overview

This section lists central Test Participants together with the name of their system(s) and whether that Participant connects to the DIP.

Participant Name	Central Party / Core Solutions Provider	Connects to DIP	System(s)
Data Integrations Service Provider (Avanade)	Central Party	n/a	DIP
Data Communications Company (DCC)	Central Party	No	Smart DCC - Data Service Provider (DSP), Central Switching Service (CSS)
Electralink (DTS)	Central Party	No	DTN
Elexon Central Systems (Helix)	Central Party	Yes	DAH directly to the DIP. Industry Standard Data Service (ISDS), Load Shaping Service (LSS), Market-wide Data Service (MDS), Volume Allocation Service (VAS), Participant Management Product (PMP) – connect to DAH Settlement Operations – connects to other Market Roles, LDSO Network Operations and National Grid ESO
Retail Energy Code Company (RECCo)	Central Party	Yes	EES
St. Clements	Core Solutions Provider	Yes	MPRS

Table 3 - Central Parties / Core Solutions Provider Overview

8.3 Data Integrations Service Provider (Avanade)

Building the Data Integration Platform (DIP) as the data exchange solution for the MHHS Programme.

8.4 Elexon Central Systems

The Elexon central systems comprises of the Balancing and Settlement Code (BSC) services. The DIP consumes industry standard data and load shapes (daily average consumption or export data for each settlement period). Consumption data and registration will flow from the DIP to the BSC central services. This will be a critical part of the central systems in the test environments.

8.5 Data Communications Company (DCC)

The DCC manages data and communications to and from smart meters and registration activity.

8.5.1 DCC – DSP

The DSP manages communications with Smart Meters.

8.5.2 DCC – CSS

The CSS is responsible for the change of supplier activity i.e., when a consumer is changing their supplier. Switching requests, objections and any updates in registration is managed when a change of supplier is secured. As this service has only been implemented in 2022, it will be an important component of test environments to ensure it works with any MHSS system changes.

8.6 Retail Energy Code Company

Organisation that owns and manages the Retail Energy Code and associated services, including the EES.

8.7 Electralink – Data Transfer Network (DTN)

The DTN is an exchange system allowing participants in the industry to exchange customer information (particularly important for settlements and changing suppliers). This is particularly important in SIT where E2E scenarios will need to be covered.

8.8 St. Clements – MPRS

The Metering Point Registration System (MPRS) is a software solution provided by St. Clements. MPRS provides the software component for satisfying OFGEM's Distribution Business' (DNO and iDNO, aka LDSO) licence conditions for the provision of a Metering Point Administration Service (MPAS).

MPRS provides a master database of Metering Point and registration data and processes data flows between the relevant market participants.

8.9 (I)DNOs' Environments

(I)DNOs are responsible for their own environments, but connection to the DIP will need to be monitored for availability and readiness (as per other Test Participant environments).

(I) DNOs may use 3rd party software providers, also known as DIP Connection Providers (DCP), to undertake testing on their behalf. It is the responsibility of both these parties to ensure that appropriate environments are available to undertake the testing that they require.

8.10 Suppliers and Agents Environments

Suppliers and Agents are responsible for their own environments, but connection to the DIP will be need to be monitored for availability and readiness (as per other Test Participant environments).

Suppliers and Agents may use 3rd party software providers, also known as DIP Connection Providers (DCP), to undertake testing on their behalf. It is the responsibility of both these parties to ensure that appropriate environments are available to undertake the testing that they require.

9 Overall Test Environment Architecture by Test Phase/Stage

9.1 MHHS Programme Target Operating Model Architecture diagram

Below is a diagram of the target operating model as expected. This section will aim to show the test environment structure based on the main system design. This section is a placeholder for when the SI is able to provide specific information on each test environment within the programme. Test system architecture will be provided under each test phase sub-section when available. Central Systems are denoted within the scope of the MHHS design:

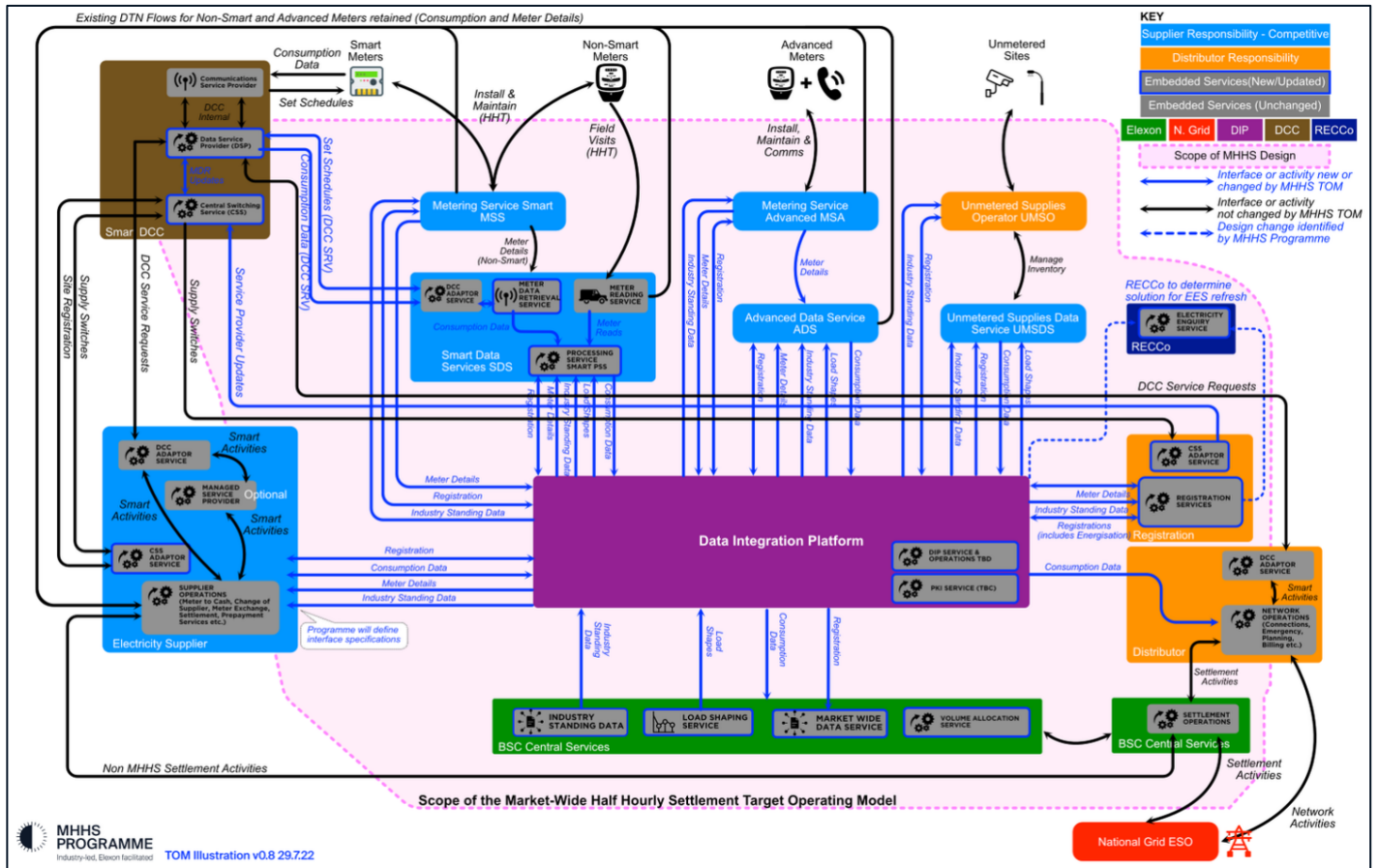

Figure 1 - Target Operating Model

9.2 MHHS Programme Test Environment

The MHHS Programme does not provide any test environments per se. A virtual MHHS Programme environment is made up of test environments provided by and under the control of the Central Parties that the MHHS Test Participants will connect to with their respective test environments.

Separate test environments will be provided for the various MHHS Programme Test Phases.

9.3 SIT – Component Integration Test

The scope of Component Integration Test (CIT) is essentially to test that messages can be sent to and from the DIP by the various Market Roles. There is no integration of test environments beyond the connection to the DIP. This is illustrated in Figure 2, below.

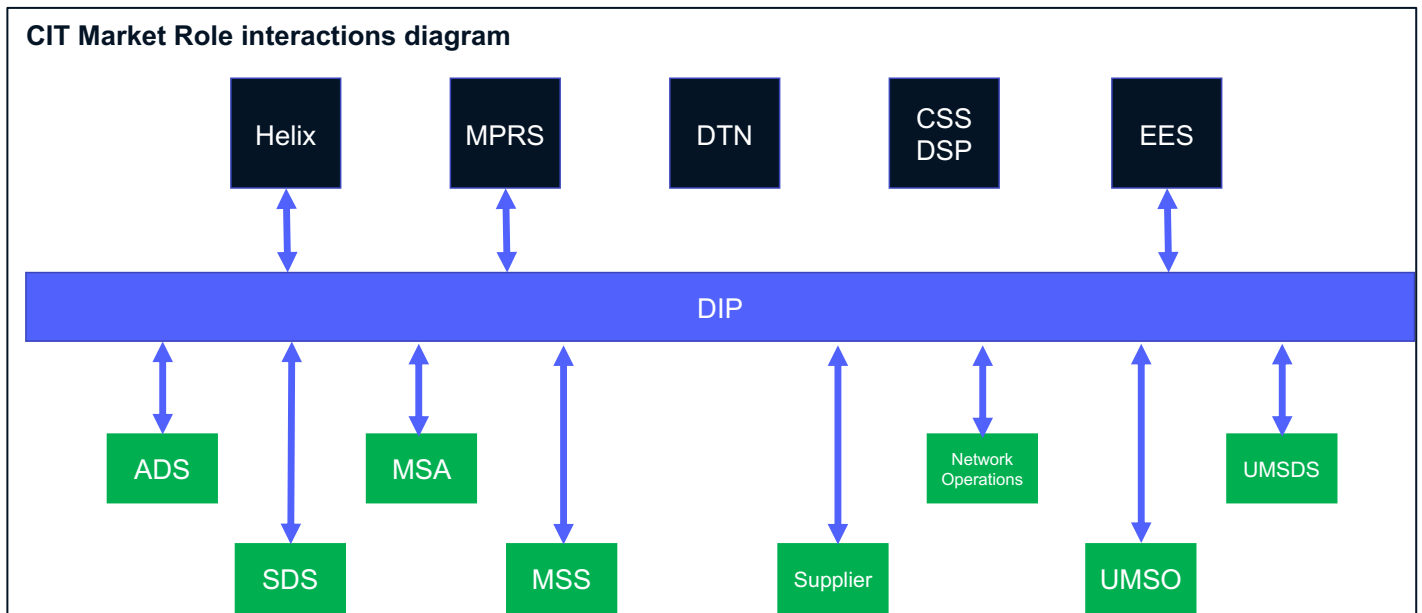

Figure 2 - CIT Market Role interactions

Three Central Parties test environments are required for CIT (DIP, Elexon (Helix) and Recco (EES)) and the Core Solutions Provider, St. Clements (MPRS) and the architecture for these environments is covered in sections 9.3.1 to 9.3.4. DCC Market Roles CSS and DSP do not connect to the DIP and consequently are not required for SIT CIT. DTN is not required for CIT, DTN is a message flow solution and does not have a test environment. Both the DCC test environment and DTN will be required for SIT functional testing.

9.3.1 DIP Test Environment

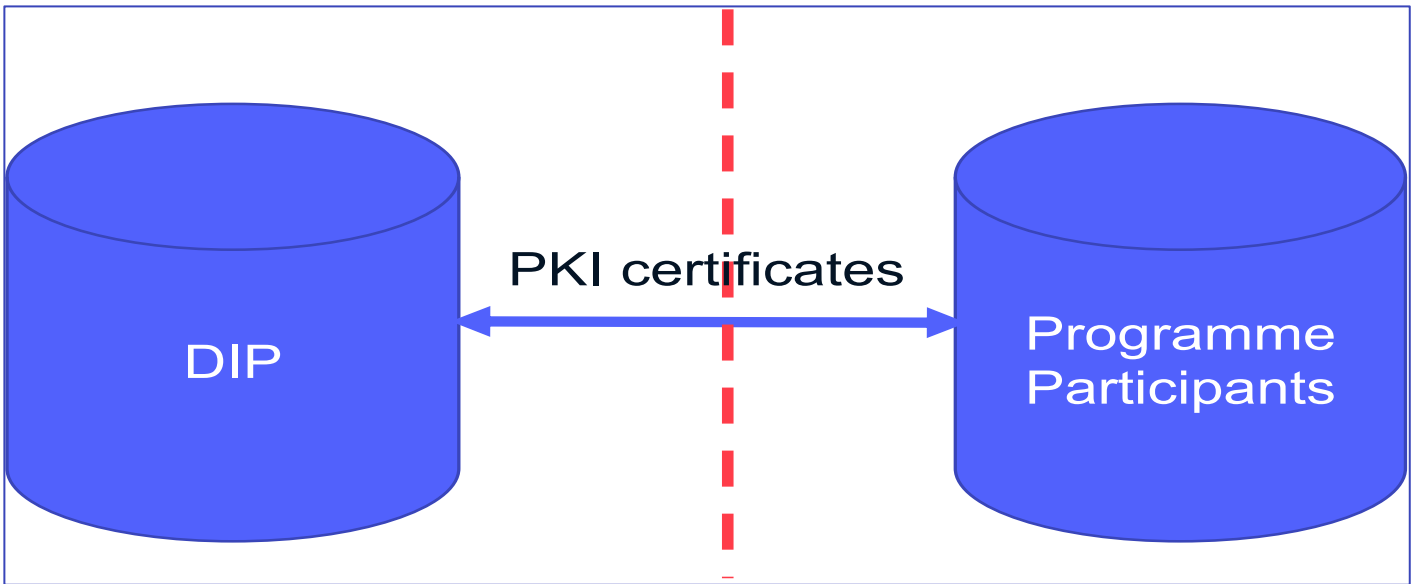

Figure 3 - DIP Test Environment

9.3.2 Elexon (Helix)

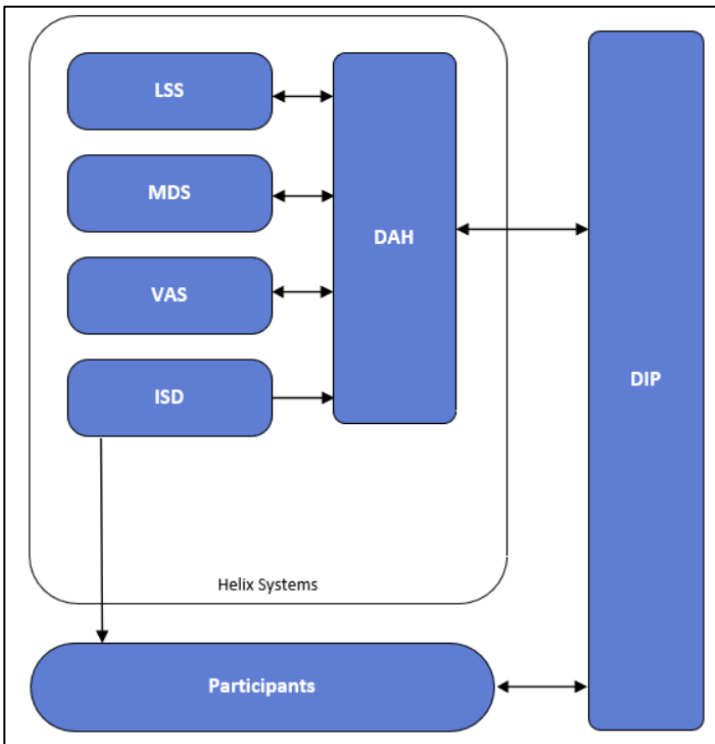

Figure 4 - Elexon (Helix) Test Environment

NB – For SIT Functional Testing an additional component will be required in the Helix test environment architecture, PMP. PMP (Participant Management Product) is a product within Elexon, a self-service gateway that offers online services that enables BSC parties to carry out tasks and manage accounts online. This includes; Digitalised Market Entry, Asset Registration, Account Management, Exiting the Market. All BSC Parties use PMP regardless of Market Role. The product was previously called Participant Management Platform.

9.3.3 Recco

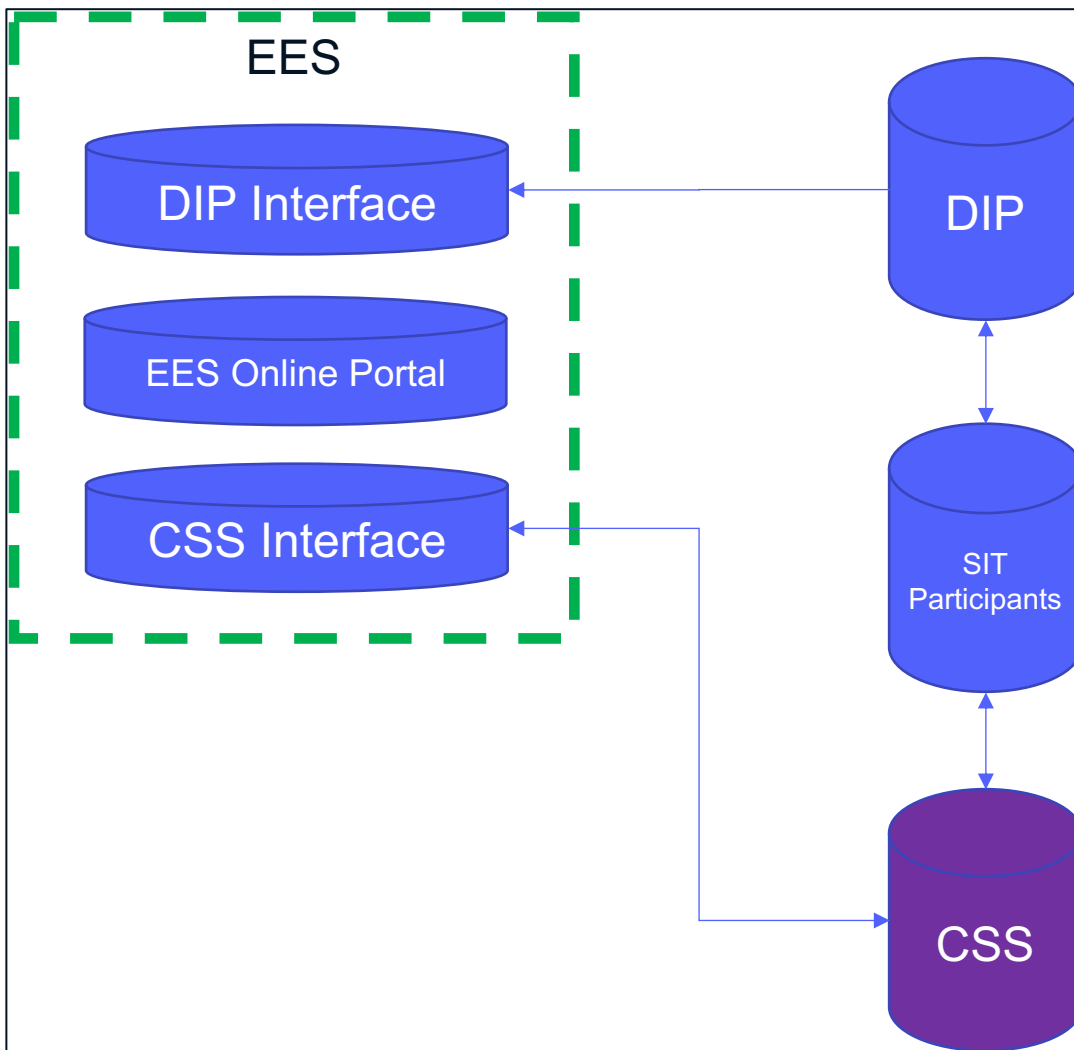

Figure 5 - Recco Test Environment

NB – During CIT the EES Test Environment will only connect to the DIP and not to CSS. Connections CSS will be relevant for SIT Functional Testing.

9.3.4 St. Clements

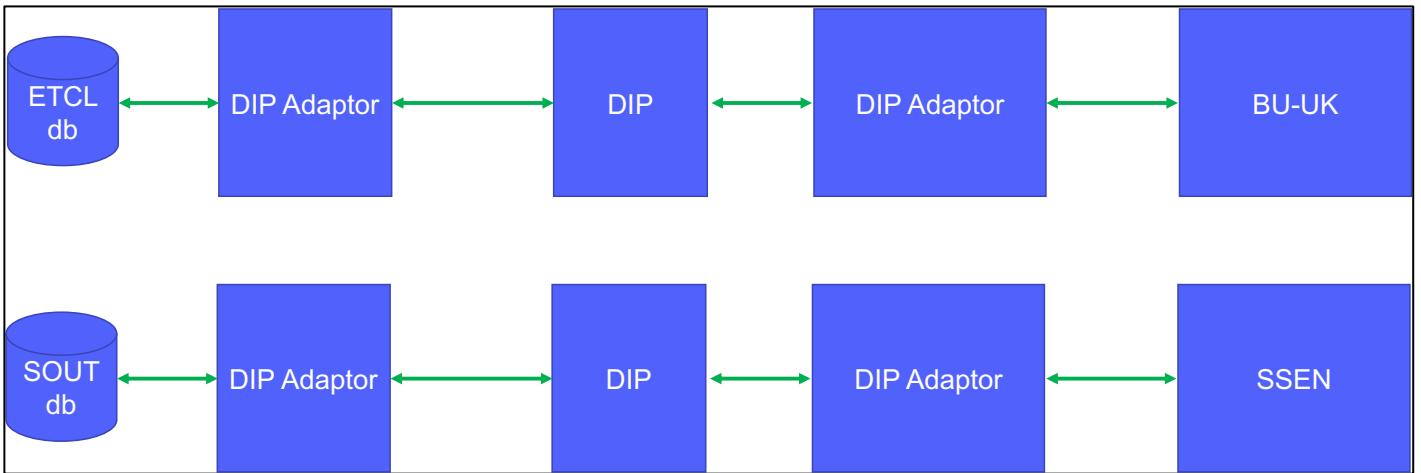

Figure 6 - St. Clements Test Environment

NB – During CIT the ETCL and SOUT databases connections will cease at the DIP. In CIT there will be no onward messaging to BU-UK or SSEN. For SIT Functional testing there will be messaging to and from BU-UK and SSEN.

9.3.5 DCC

CSS and DSP do not connect to the DIP and consequently there is no requirement for a DCC test environment to support CIT.

9.3.6 Electralink

Electralink do not provide a test environment. The DTN solution provides 'Test Flags' that are used to route message flows to and from testing participants. There is no requirement to utilise DTN during CIT. Electralink is expected to update the DTN flow structure and routing to reflect MHHS changes (e.g. new market roles) for use in SIT functional testing.

9.4 SIT Functional Testing

SIT Component Integration Testing is limited to testing message flows to and from the DIP. SIT Functional Testing is an end to end test phase and will require various Central Party and SIT volunteer test environments to be integrated.

9.4.1 Avanade - DIP

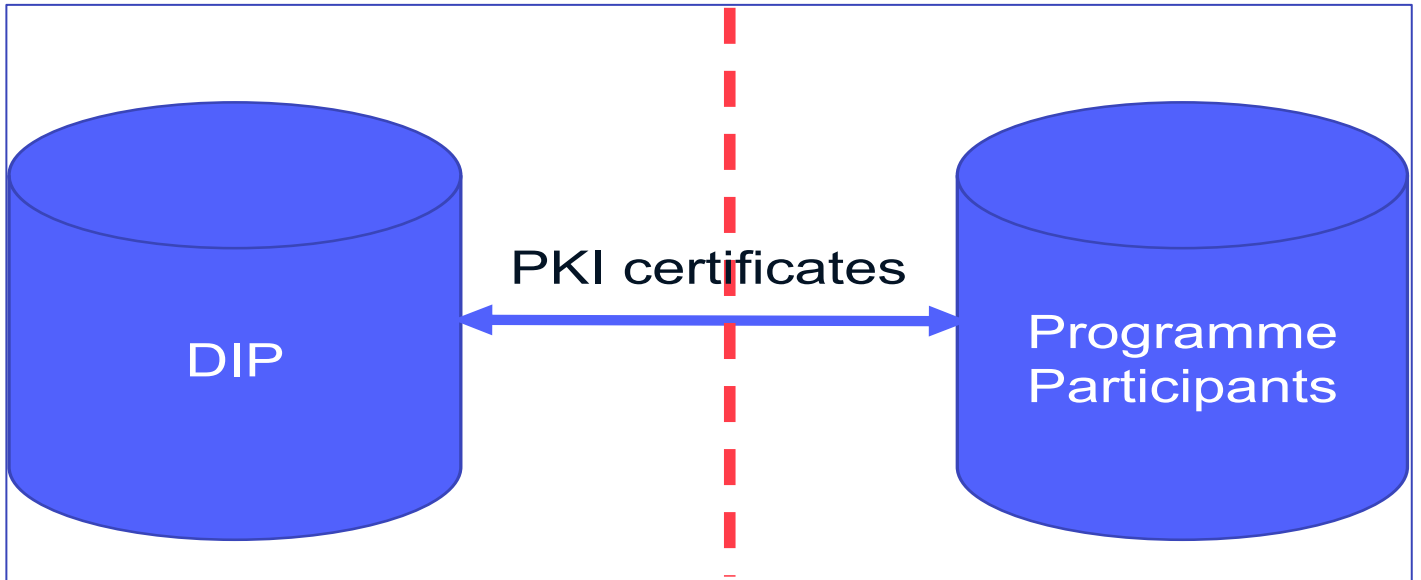

Figure 7 Avanade SIT Functional Test Environment Architecture

9.4.2 DCC

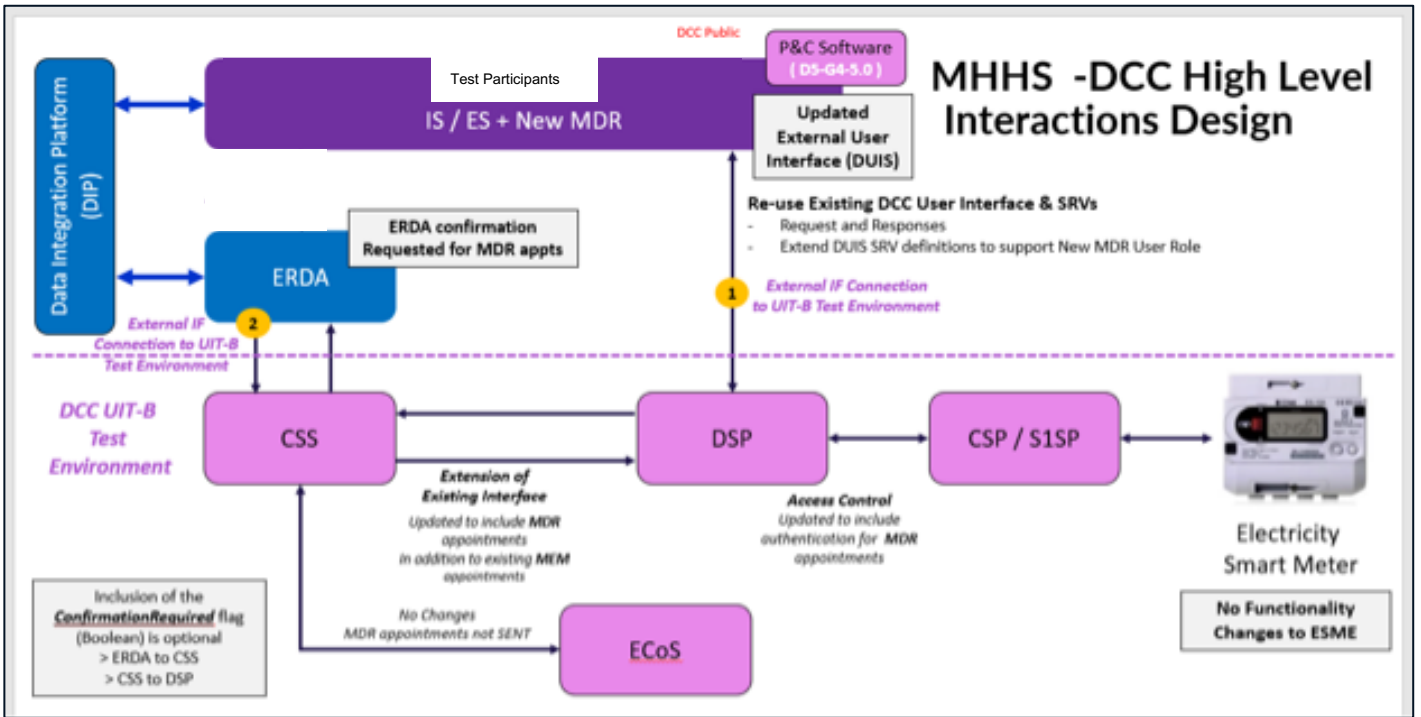

Figure 8 DCC UIT-B Test Environment Architecture

The DCC UIT-B Test Environment does not connect to the DIP. MHHS Programme Participants will need to connect to the DCC UIT-B environment using DCC CSS PKI certificates via DCC BAU processes. MHHS SIT Participants testing the SDS Market Role with the MDR component will need to connect to the DSP instance, and will require DCC DSP PKI certificates. The MHHS Programme and DCC have worked together to ensure that support material has been provided and this has been cascaded following the October EWG.

9.4.3 Electralink

Electralink do not provide a test environment and do not connect to the DIP. Electralink provide a Data Transfer Network (DTN) to Industry Participants. The MHHS Programme design is introducing a number of changed and new D-Flows. SIT Functional Test Cases reference these D-Flows and therefore these flows will require to be tested in SIT Functional Testing. It is possible to configure DTN so that 'test flags' can be set so that D-flows are routed to test environments and not production environments. The setting of 'test flags' is a BAU function of the DTN. The MHHS Programme and Electralink will work together to define the usage of test flags and then communicate to MHHS Test Participants.

[REF-11] MHHS – DES196 – D-Flow and Interface mapping contains a list of all of the D-flows that are changing as a result of the MHHS Programme. A number of D-flows are referenced in that document that are not referenced in the table below. For the avoidance of doubt, it should be assumed that if a D-Flow is new or changed it should be tested in MHHS SIT, either Functional or non-Functional. As the SIT Functional Test Cases are developed the MHHS Programme will be able to validate that the relevant D-Flows are included in the scope of MHHS SIT testing.

For clarity the following sections define which d-flows are sent / received by each MHHS Market Role.

9.4.3.1 D-Flows in the scope of MHHS Design for SIT Functional Testing

D-Flow	Name
D0010	Meter Readings
D0036	Validated Half Hourly Advances for Inclusion in Aggregated Supplier Matrix
D0132	Details of Disconnection of Supply
D0134	Request to Change Energisation Status
D0139	Confirmation or Rejection of Energisation Status Change
D0142	Request for Installation or Change to a Metering System Functionality or the Removal of All Meters
D0149	Notification of Mapping Details
D0150	Non Half-hourly Meter Technical Details
D0170	Request for Metering System Related Details
D0179	Confirmation of Energisation/De-Energisation of Prepayment Meter
D0215	Provision of Site Technical Details
D0221	Notification of Failure to Install or Energise Metering System
D0225	Priority Services Details
D0262	Rejection of Disconnection
D0268	Half Hourly Meter Technical Details
D0275	Validated Half Hourly Advances
D0302	Notification of Customer Details
D0354	Metering System Reporting Notification
D0388	UMS Inventory
D0389	UMS Response
D0397	Supplier Half Hourly Demand Report
D0398	Supplier Settlement Header Report
D0399	GSP Group Consumption Totals Report
D0400	Supplier BM Unit Report
Deeee	MHHS Aggregated Disconnected DUoS Report
Dffff	MHHS Supplier Half Hourly Demand Disconnection Report
Dgggg	MHHS GSP Group Demand Disconnection Totals Report
Dhhhh	MHHS Supplier BM Unit Demand Disconnection Report

Figure 9 DTN D-Flows in scope for SIT Functional Testing

9.4.3.2 Supplier

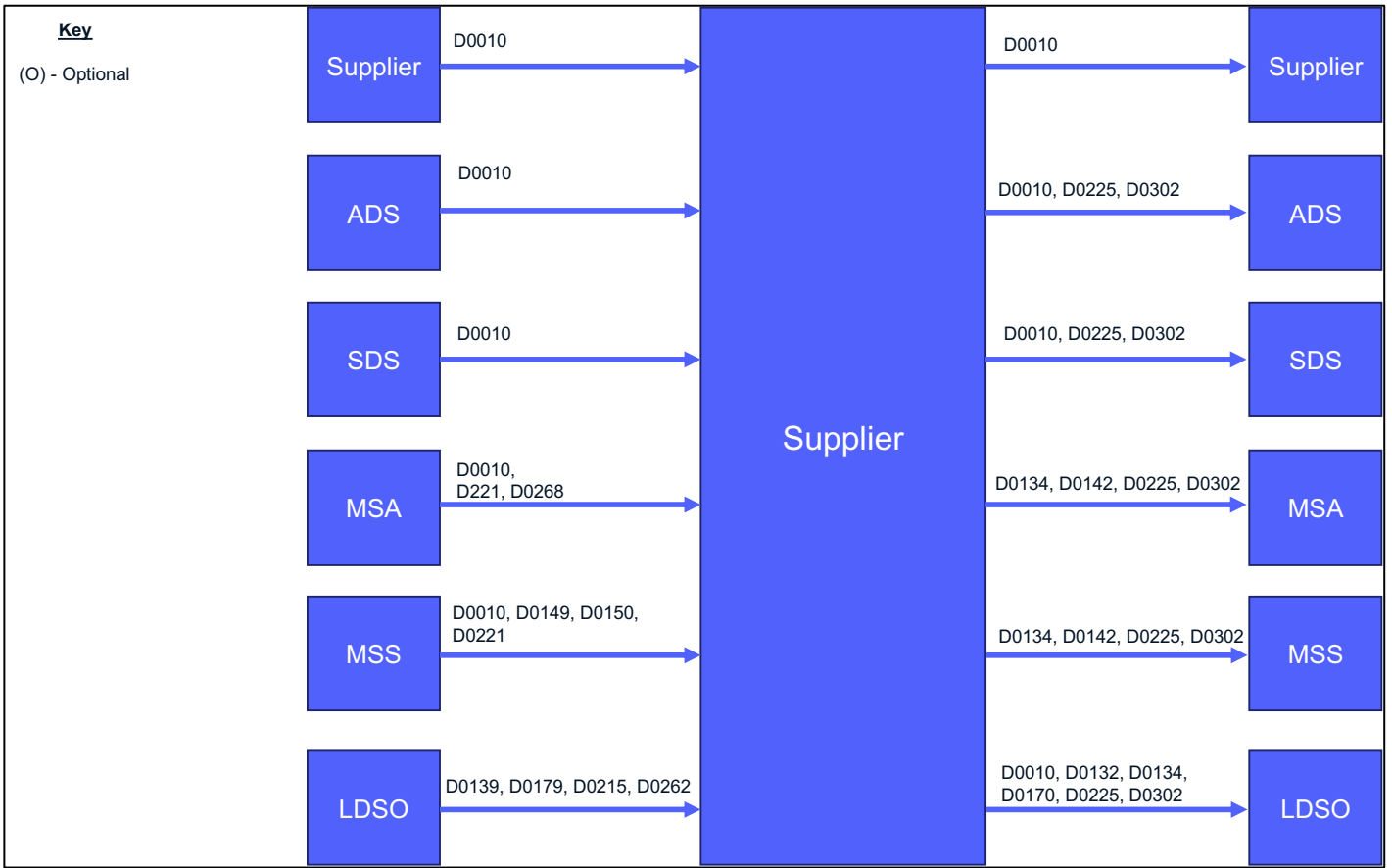

Figure 10 Supplier D-Flows

9.4.3.3 ADS

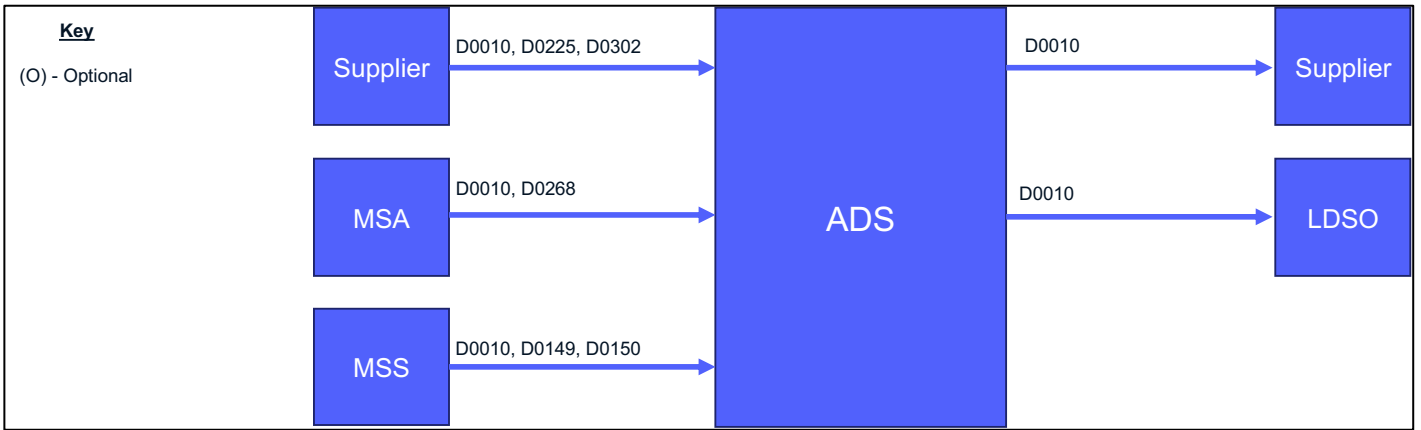

Figure 11 ADS D-Flows

9.4.3.4 SDS

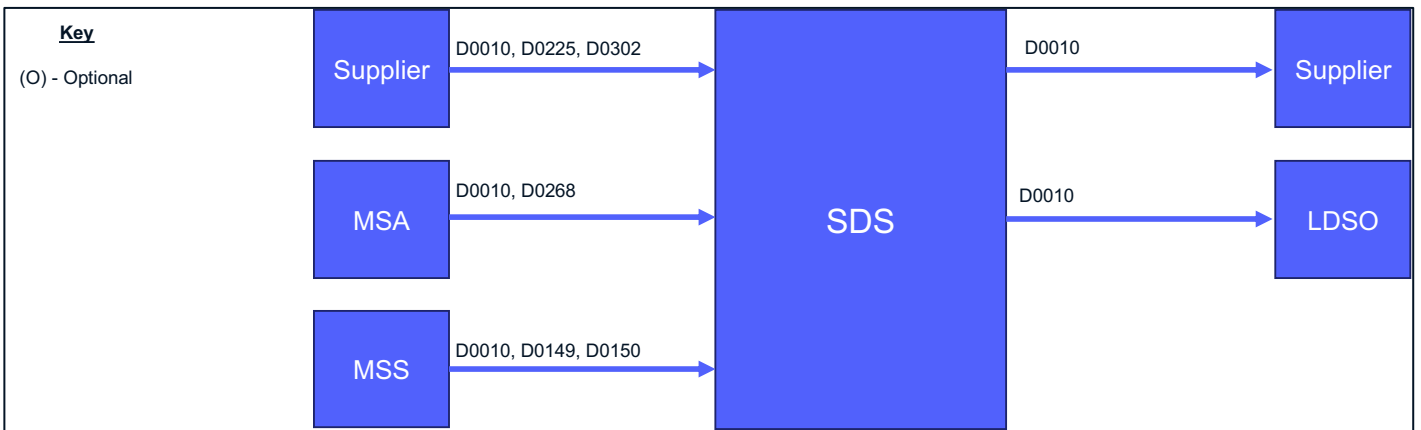

Figure 12 SDS D-Flows

9.4.3.5 MSA

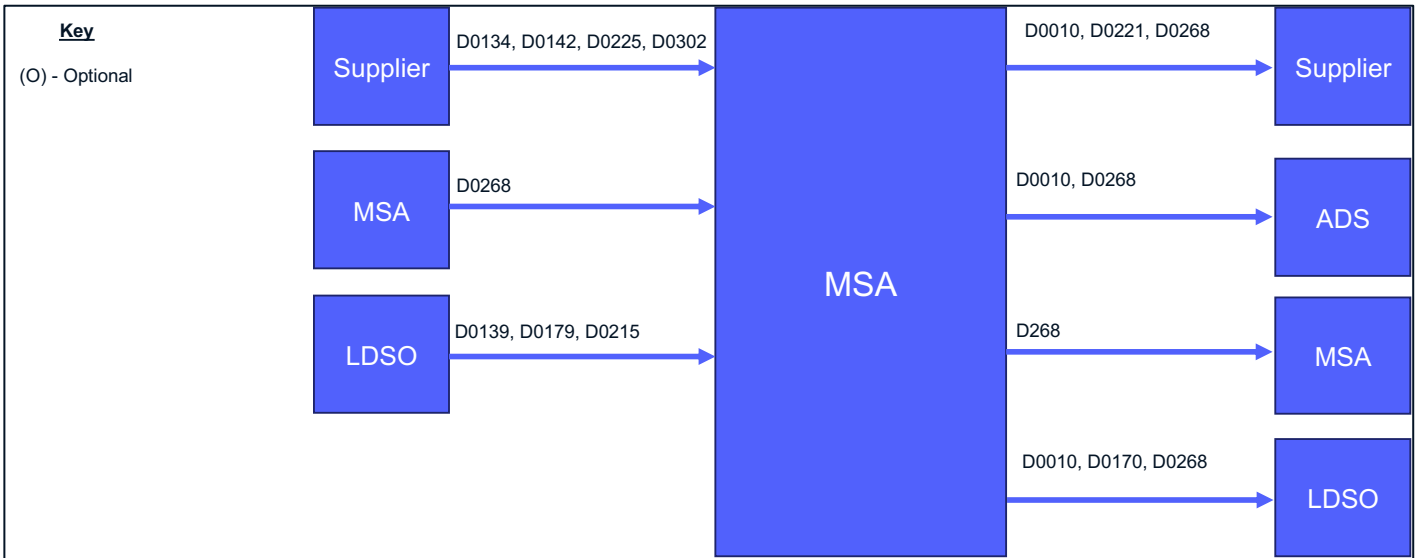

Figure 13 MSA D-Flows

9.4.3.6 MSS

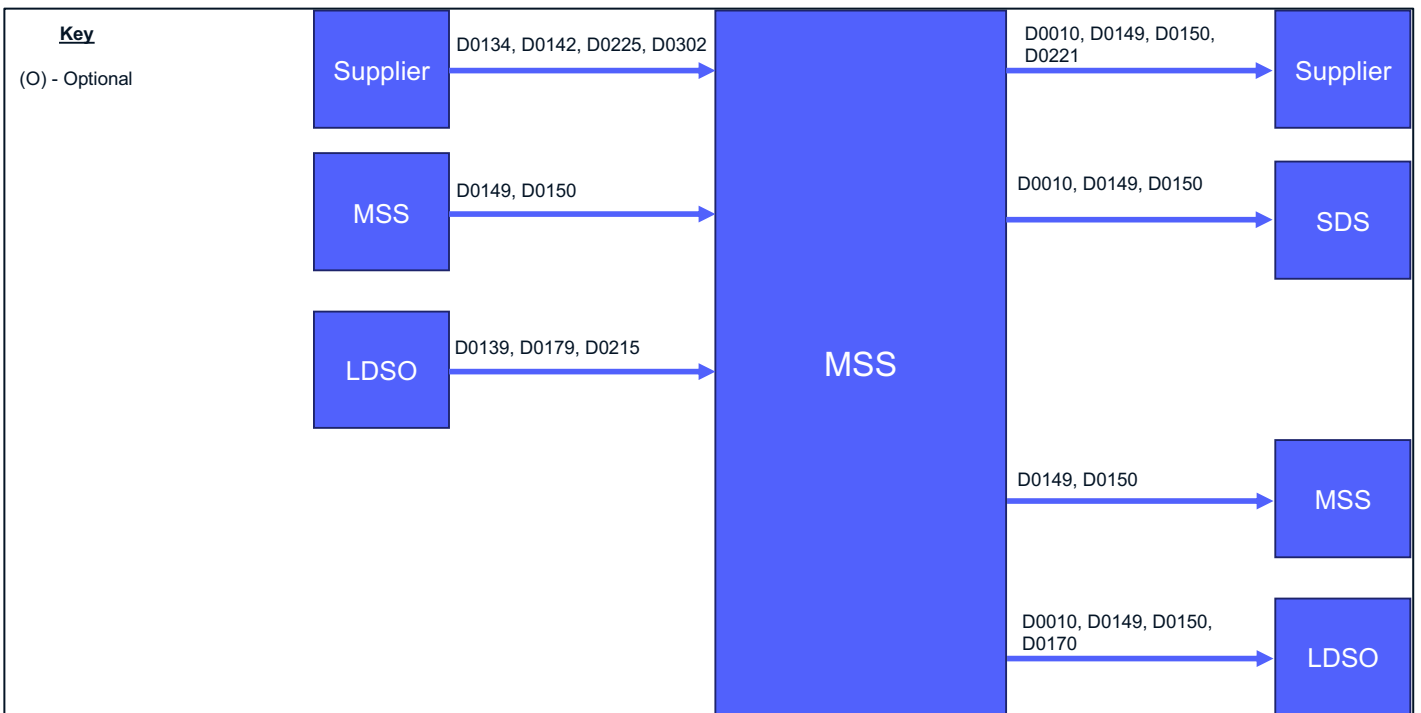

Figure 14 MSS D-Flows

9.4.3.7 LDSO



Figure 15 LDSO D-Flows

9.4.3.8 UMSO

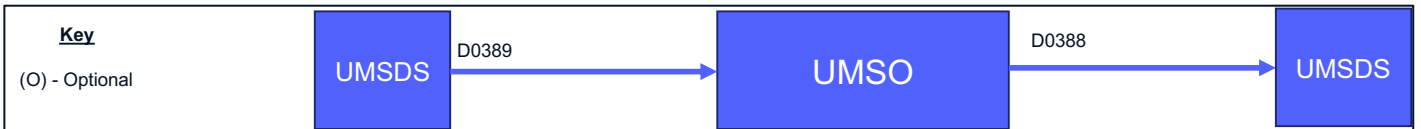

Figure 16 UMSO D-Flows

9.4.3.9 UMSDS



Figure 17 UMSDS D-Flows

9.4.3.10 Helix

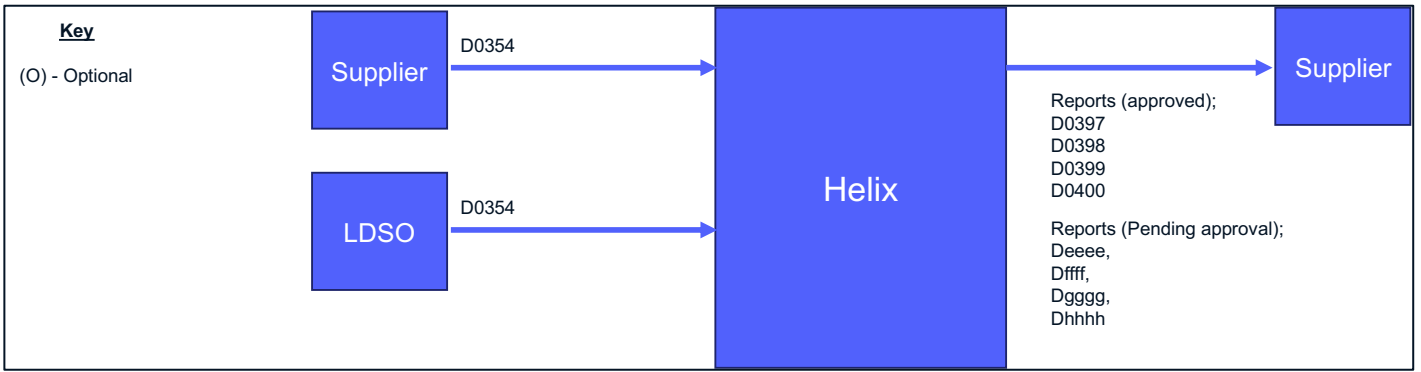

Figure 18 Helix D-Flows

9.4.4 Elexon (Helix)

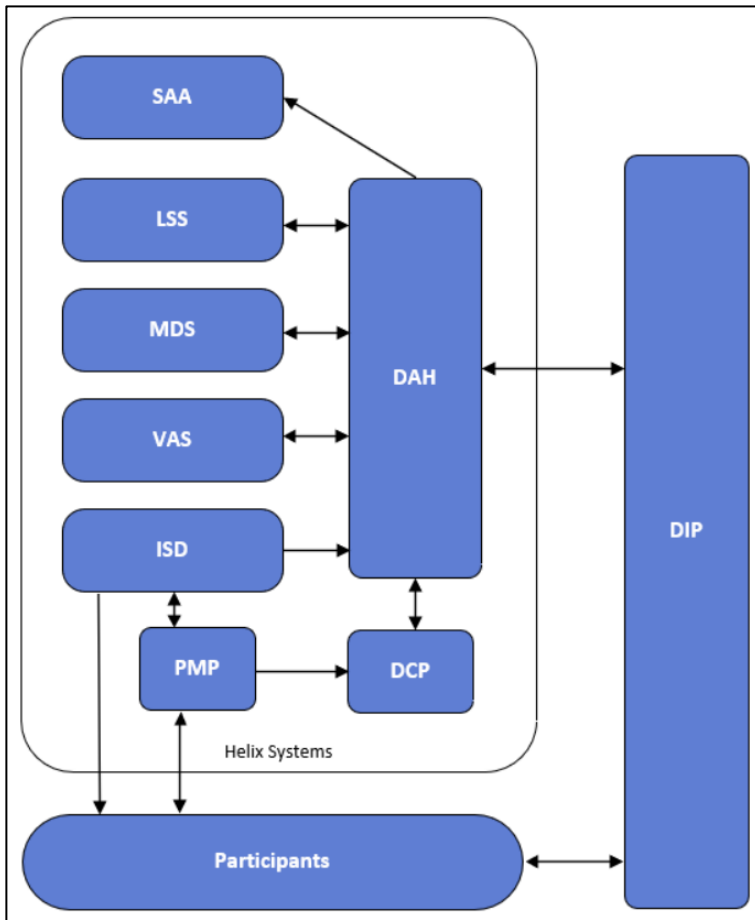

Figure 19 Helix SIT Functional Test Environment Architecture

9.4.5 Recco

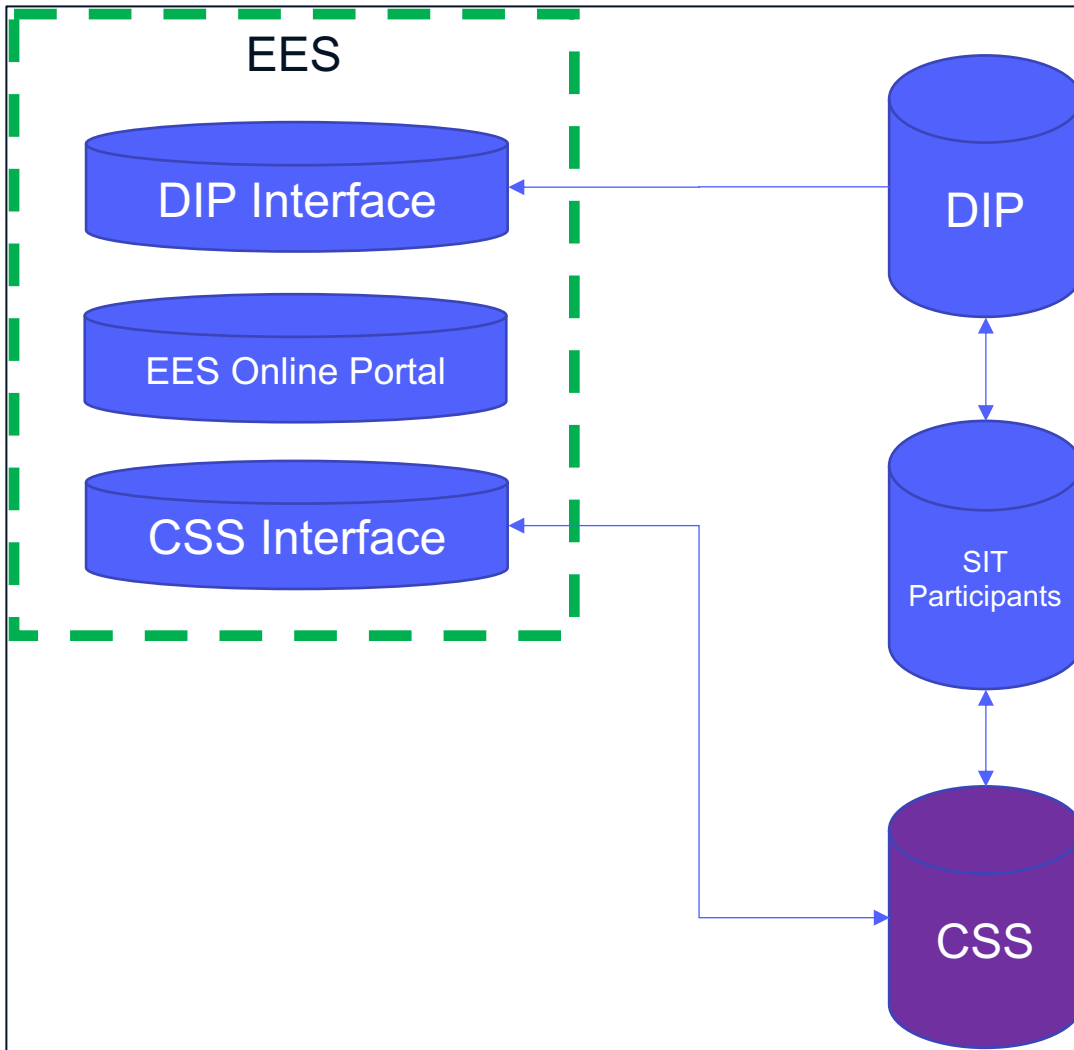

Figure 20 Recco SIT Functional Test Environment Architecture

Assumption – The EES Customer API is not planned to be made available in the SIT Functional environment. If SIT Participants believe that they require access to the EES data in SIT then this will need to be discussed with RECCo.

9.4.6 St. Clements

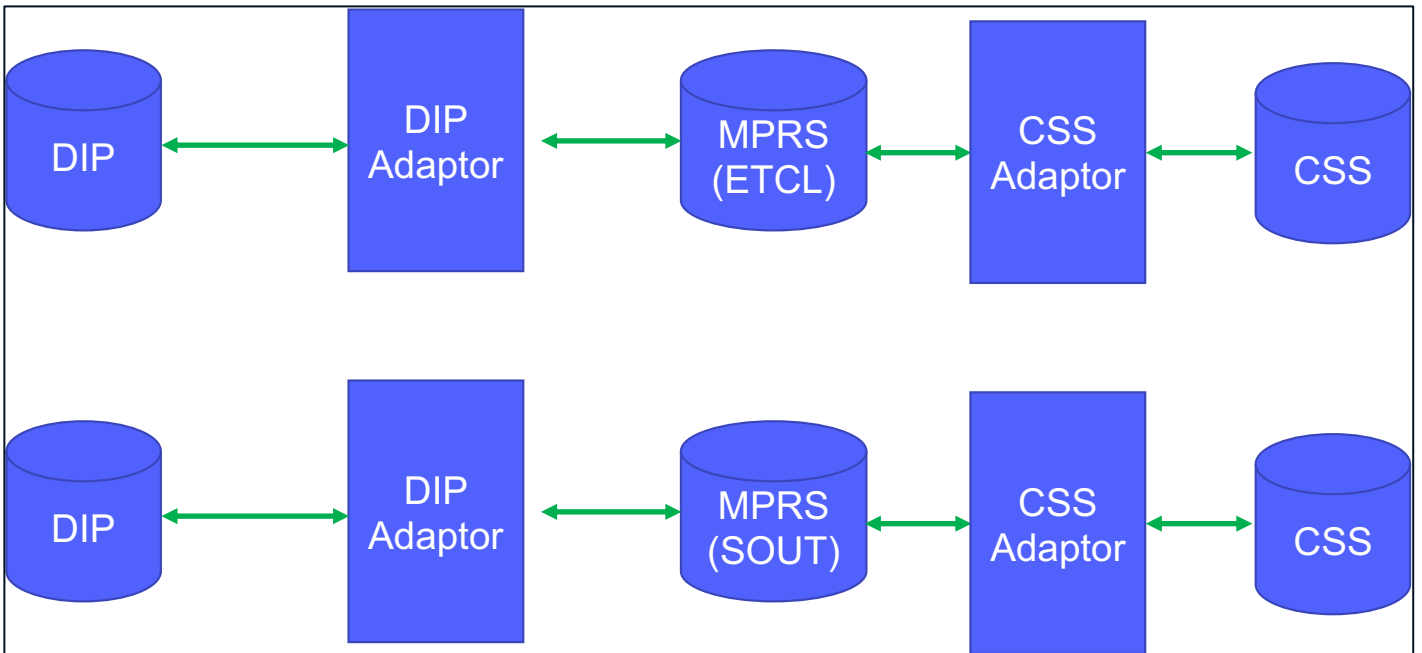

Figure 21 St. Clements SIT Functional Test Environment Architecture

9.4.6.1 DB Flows

In addition, during SIT Functional testing DB flows will be utilised to send data from the LDSO (role R) to MPRS (role P);

- DB01 – new metering point
- DB02 – update metering point
- DB03 – disconnect metering point
- DB05 – import / export relationships

9.5 SIT Non-Functional Testing

Central Parties will provide a separate test environment for SIT non-functional testing. The environment architecture for these environments is a work in progress. Further detail on the Central Parties non-functional test environment architecture and how they will be integrated will be included in future versions of this document.

9.6 Non-SIT LDSO Qualification Testing

Discussions are ongoing within the Code Bodies and MHHS Programme in order to determine the scope of non-SIT LDSO Qualification Testing. When these discussions have concluded an assessment will be made as to which test environment is best suited to host non-SIT LDSO Qualification Testing.

9.7 Qualification / Sandbox

The exact nature of the test environment architecture required for the Qualification phase is a work in progress. Further detail on the Central Parties Qualification test environment architecture, any use of test stubs and how the environments will be integrated will be included in future versions of this document.

There is no separate Sandbox environment. Any Sandbox activity will be executed in the Qualification environment and is dependent on the Test Participant having successfully completed the Qualification tasks.

9.8 Staging Environments

The purpose of a staging environment is to ensure that changes are tested prior to deployment in order to ensure that the MHHS test environments are not broken when new code is deployed.

Each of the Central Parties / Core Solutions Provider will have an environment where they undertake regression testing for change and defect retesting. This is a staging environment but is not necessarily dedicated to MHHS, nor connected to the DIP.

9.8.1 Avanade

Avanade do not have an explicit Staging Environment, Avanade will use their PIT environment to test any changes and / or fixes.

Therefore, the Avanade PIT environment is their Staging Environment.

9.8.2 DCC

DCC are providing a single test environment to support MHHS testing, the DCC UIT-B environment. Provision of an additional test environment was deemed to be prohibitively expensive. DCC will not be deploying any fixes or changes directly into the UIT-B environment, they will first undergo testing in the SIT-B environment.

Therefore, DCC SIT-B is their Staging Environment.

9.8.3 Electralink

Electralink do not have a test environment. The DTN provides the capability to send test data flows and the MHHS Programme will use this in SIT and Qualification testing.

9.8.4 Elexon / Helix

Helix do not have a staging environment dedicated to MHHS. Helix will be using their Helix Integration Staging (STGI) environments to test code deployment, regression testing and CRs during SIT functional, non-functional and qualification phases.

Therefore, the Helix Integration Staging environment is their Staging Environment.

9.8.5 Recco

Recco do not have a dedicated staging environment, they will however be testing any changes / fixes prior to deploying to their SIT environment.

Therefore Recco have a Staging Environment.

9.8.6 St. Clements

St. Clements do not have a dedicated staging environment, they will however be testing any changes / fixes prior to deploying. Any code that is required to be deployed to the SIT Functional or SIT Non-Functional environments will have been tested in other existing St. Clements environments prior to deployment.

Therefore St. Clements have a Staging Environment.

10 Connecting to the DIP

10.1 DIP Onboarding

Test Participants will onboard in line with their respective CIT Interval, this has been communicated in the September and October EWGs and has been discussed in TMAG.

DIP Onboarding will take place as follows;

Interval 1- w/c 9th October

Interval 2 – w/c 16th October

Interval 3 – w/c 30th October

Interval 4 – w/c 13th November

Interval 5 – w/c 27th November

Interval 6 – w/c 4th December

It is anticipated that once DIP Onboarding has been completed for Interval 3 that the remaining SIT Participants will be able to commence DIP Onboarding.

NB – At present the focus is onboarding SIT Participants. Programme Participants that are going to participate in Qualification Testing will complete DIP Onboarding at a later date, but prior to the commencement of Qualification Testing.

Please refer to [REF-10] MHHS DEL1671 DIP Onboarding Guide for details regarding DIP Onboarding.

10.2 Code of Connection

For both SIT and Qualification / UIT, Test Participants will be responsible for connecting their own systems to the DIP. Guidance for this will be available on the [REF-06] MHHS DIP 094 Interface Code of Connection Guide via the [design](#) documentation.

10.2.1 Registration Responsibilities

The [REF-06] MHHS DIP 094 Interface Code of Connection Guide specifies the requirements for the appointment of individuals responsible for certificate registration.

10.2.2 PKI Certificate Expiry

PKI Certificates are only valid for a set period of time, please refer to the [REF-06] MHHS DIP 094 Interface Code of Connection Guide for certificate valid periods.

Lessons learned from the Faster Switching Programme highlight that PKI certificate expiry has the potential to impact test execution if Test Participants fail to identify that PKI certificates are due to expire and are not replaced prior to expiry. There were numerous instances where this occurred on the Faster Switching Programme.

Each test execution phase will be preceded by a Connectivity Proving phase. The Connectivity Proving Phase is the point at which PKI certificates are requested and installed.

For SIT Functional Testing the current timeline assumptions, based on the Test Plan published as part of the Round 3 Consultation state a combined timeline for Connectivity Proving plus SIT Functional Test of ~15 to 19 months. During this period some PKI certificates for Test Participants will expire and Test Participants will need to request new PKI certificates.

For UIT Qualification Testing it is assumed that each Tranche will be ~ 6 months, preceded by a Connectivity Proving Phase. It is therefore unlikely that a PKI certificate will expire during Qualification Testing. However, if a Programme Participant was in the early Qualification Tranches and continued to access the Sandbox until the final point that the environment is available it is possible that the original PKI certificate for the Qualification environment may expire and a replacement PKI certificate would be required.

NB - It is the responsibility of Test Participants to ensure PKI certificates are renewed at the appropriate point in time in order to ensure that there is no downtime that would impact test execution.

NB – Test Participants do not need to wait for a PKI certificate to expire before they request and install a new PKI certificate.

10.2.3 Certificates by Environment

Each Test Environment will require a different set of PKI certificates. Certificates issued for the SIT-A Test Environment will not establish connection to the SIT-B or Qualification / UIT Test Environments and vice versa. The [REF-06] MHHS DIP 094 Interface Code of Connection Guide will specify what types of certificates are required.

10.3.1 Connecting to the DCC Test Environment

The DCC test environment will be UIT-B. It should be noted that MHHS SIT Participants will not be able to connect two different MHHS environments (SIT-A Functional and SIT-B non-Functional) to the single instance of the DCC UIT-B environment. The MHHS Programme is aware of this limitation and is taking steps to address, most likely by scheduling testing appropriately.

MHHS SIT Participants testing the SDS Market Role with the MDR component will need to connect to the DSP instance, and will require DCC DSP PKI certificates. As a pre-requisite for MHHS SIT Functional Testing these participants must have completed DCC UEPT.

Suppliers will need to connect to the CSS instance.

EES and Registration Services will need to connect to the CSS instance.

Any MHHS SIT volunteers that will be connecting to the DCC test environment will need to utilise existing DCC processes in order that they have the appropriate PKI certificates in place. For DSP this is the same process that is used for Production and Test Certificates. For CSS this will be the same process that is used for Production and Test Certificates.

The MHHS Programme has worked with the DCC to ensure that support material has been provided to aid MHHS Programme Participants navigate the DCC PKI Onboarding processes. DCC have shared support material with the MHHS Programme and an overview of the material was socialised at the October Environments Working Group, this included points of contact within the DCC. The support material has been cascaded to MHHS Programme Participants alongside the October EWG Headline Report. The DCC Support material will be made available on the MHHS Collaboration Base.

To reiterate – the process by which MHHS SIT volunteers will request DCC PKI certificates is via existing, business as usual DCC processes.

In order to request PKI Certificates PKI Officers must be in place.

For the DCC CSS PKI solution the PKI Officers are assigned to the organisation. There are not separate PKI Officers for Production and Test environments, except in the case of Technical Contacts.

The PKI Officers are; Nominating Officer, SRO, ARO, Technical Contact.

- Nominating Officer and SRO are mandatory and there can only be 1. ARO is optional but there can only be a maximum of 1. Technical Contacts are unlimited, can be from any organisation and are appointed by the SRO of the 'Licenced Party' on an MPID / Market Role and Environment basis.
- A Technical Contact must have been appointed to the MPID / Market Role and test environment combination in order that they can request a PKI certificate.

Just because a Technical Contact is able to request a PKI certificate for an MPID / Market Role for the Production environment it does not mean that they will be able to do so for a test environment unless the SRO of the Licenced Party has appointed them.

The MHHS Programme is in discussion with DCC regarding DCC providing 'Help' material to MHHS SIT volunteers in order to assist them navigating the DCC PKI Processes.

The current MHHS Programme Plan does not contain milestones or activities for when the MHHS Programme requires MHHS SIT volunteers to request PKI certificates from DCC. This will change and shortly tasks will be added to the MHHS Programme Plan.

It is anticipated that the date by which it is expected that MHHS SIT volunteers will have their UIT-B PKI certificates in place for CSS is no later than 15th December, 2023.

MHHS SIT volunteers are strongly encouraged to take steps to ensure that they have the appropriate DCC CSS PKI Officers in place so that they can request PKI certificates AND so that they can appoint Technical Contacts to the appropriate MPID / Market Role & test environment combination for any 3rd party that may be requesting PKI certificates on their behalf. There is nothing to prevent MHHS SIT volunteers undertaking this activity now.

10.3.2 Connecting to Helix PMP

It is anticipated that SIT volunteers will need to access the Helix PMP instance directly. The Market Roles that will require this access are in the process of being determined, but are thought to include all Market Roles.

It is anticipated that a 'user account' will be required to access the PMP instance. A template is in the process of being defined to capture user details. Discussions are ongoing to determine whether individual user accounts or a single account per Test participant will be provided.

The current MHHS Programme Plan does not contain milestones or activities for when the MHHS Programme requires MHHS SIT volunteers to have secured access to Helix PMP. This will change and shortly tasks will be added to the MHHS Programme Plan.

It is anticipated that the date by which it is expected that MHHS SIT volunteers will have their user access to Helix PMP in place is prior to the commencement of SIT Functional Testing. Information will be provided to MHHS SIT Participants at the earliest opportunity.

11 Test Phases and Concurrent Environment Requirements

This section will highlight the high-level MHHS Programme SIT and UIT Test Plan and the concurrent test environments required for participants for the different test phases.

11.1 High Level MHHS Test POAP

Figure 8, below states the timelines of the different test phases of the Programme. The POAP is included in this document to aid the reader and provide a ready reference point. The POAP reflects the Programme Test Planning assumptions at the point of CR22.

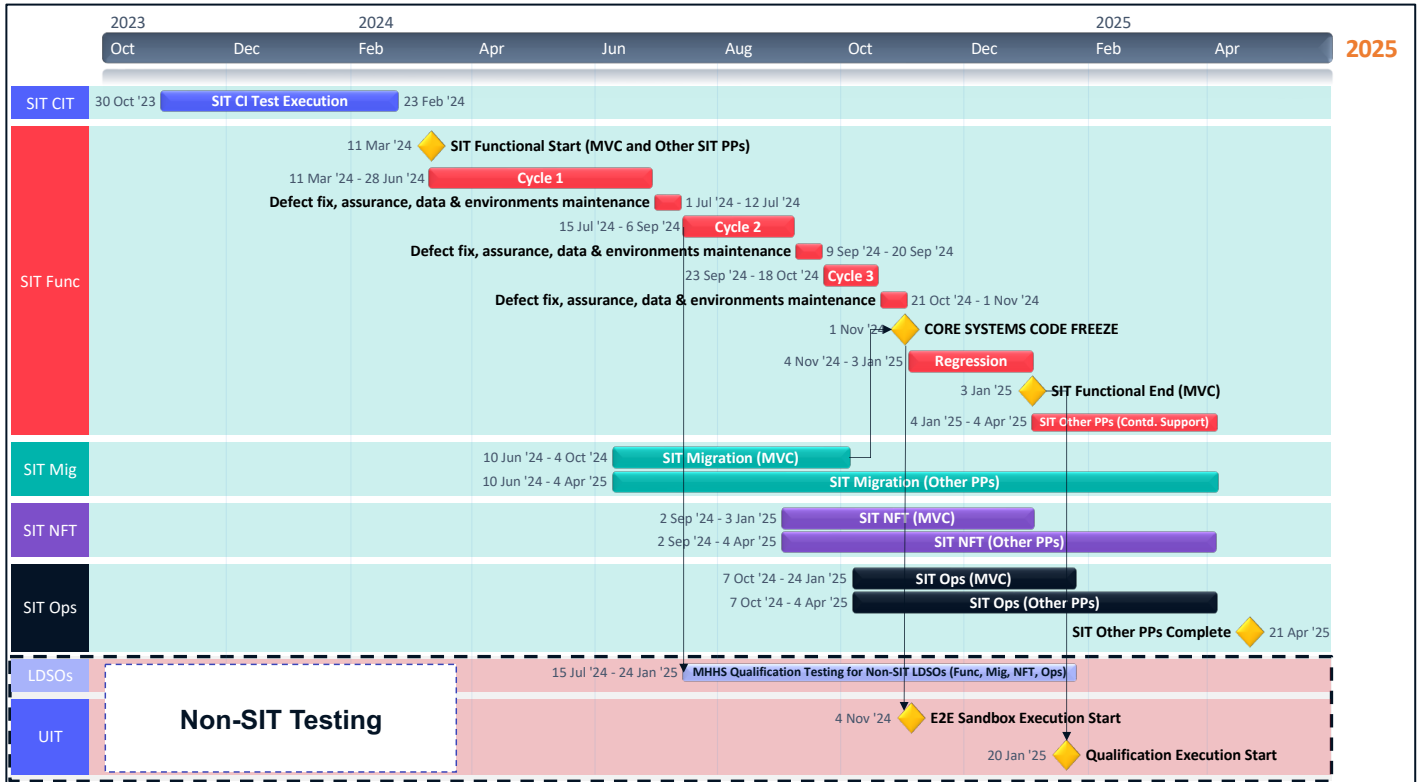

Figure 22 - High Level MHHS Test POAP

11.2 MHHS Environments Timeline

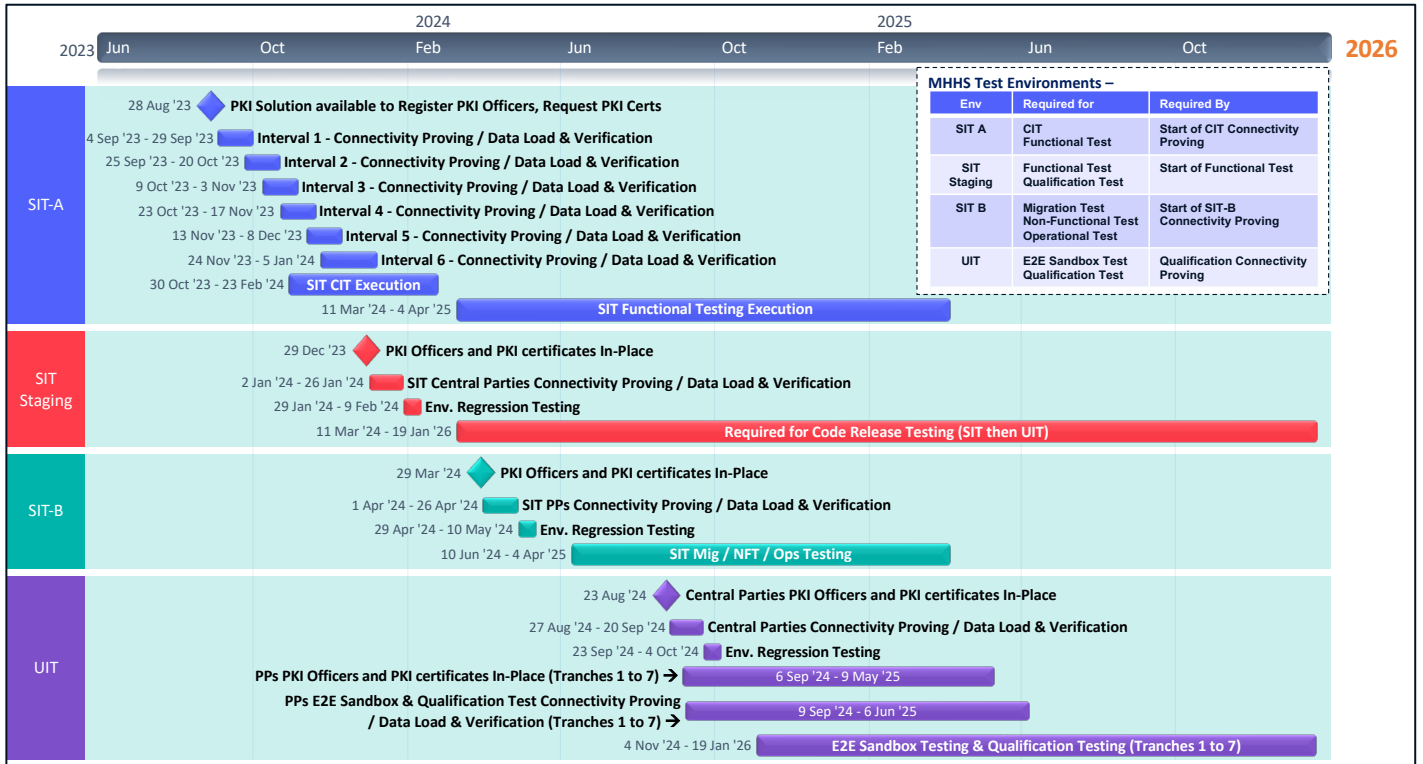

Figure 23 - MHHS Environments Timeline

11.2.1 Non-SIT LDSO Qualification Testing Environments timeline

The MHHS Programme and Code Bodies have been in discussion regarding non-SIT LDSO Testing. Discussions are ongoing and at present it has not been possible to state the environments required to support non-SIT LDSO testing. It is anticipated that they will be provided in the next version of this document.

11.3 CIT Connectivity Proving

Environment Connectivity Proving is essentially establishing Environment Readiness and will include Programme Parties;

- requesting and installing PKI (TLS & JWS) certificates,
- registering Webhooks,
- Programme Participants ensuring the end to end connectivity of their test environments and connection established to the DIP.

Lessons learned from previous large-scale industry programmes have identified that establishing and proving connectivity prior to the start of testing for Programme Participants has been problematic. These problems have tended to impact the commencement of test execution. A dedicated Environment Connectivity Proving stage will enable connectivity activities to be more closely monitored and supported and will act as a Quality Gate for subsequent test activities.

Programme Parties will need to undertake activities that prove their internal connectivity and external connectivity. These activities can be undertaken independently of each other and can be in any sequence, although there are dependencies within each activity. For the External Connectivity activities PKI Certificates must be requested and installed before Webhooks can be registered. For the Internal Connectivity activities Test Participants should ensure that they have their test environments stood-up.

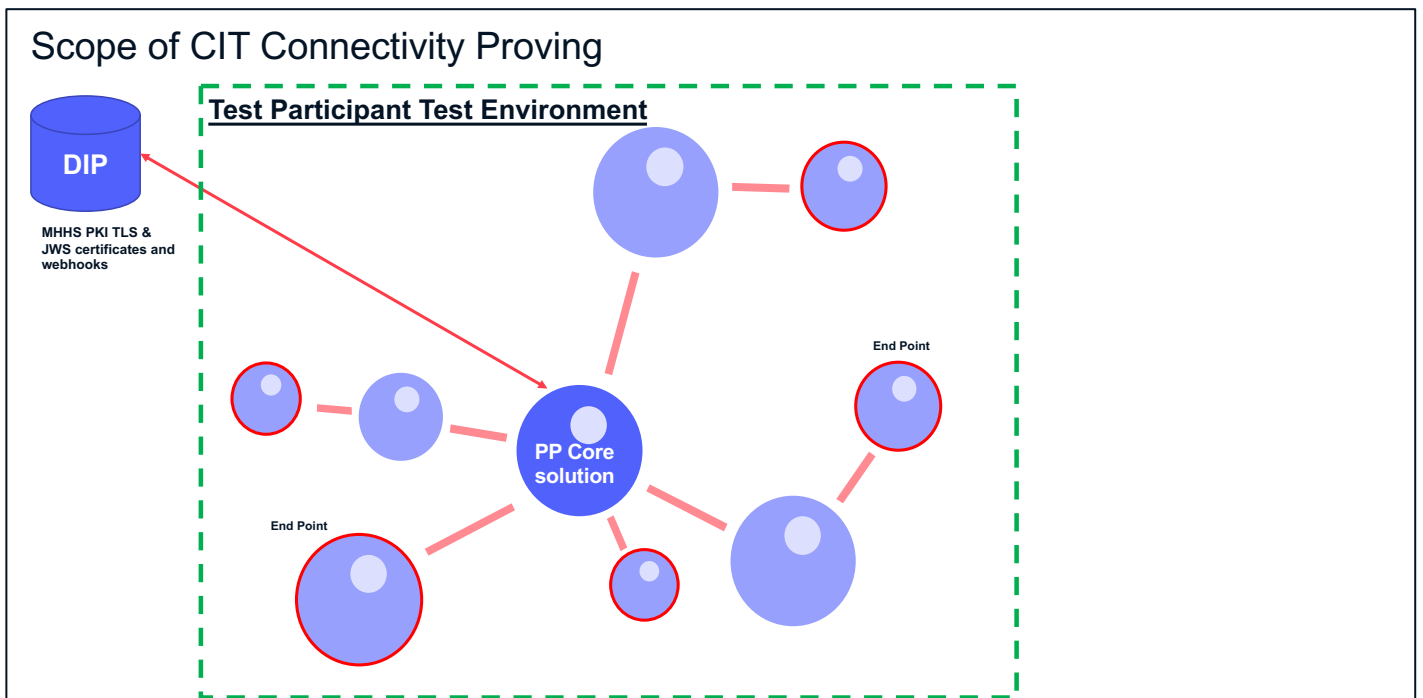

Figure 24 - Scope of CIT Connectivity Proving

11.3.1 External Connectivity

11.3.1.1 Requesting & Installing PKI Certificates

NB - Programme Participants must have determined who their PKI Officers will be prior to the commencement of the DIP Onboarding activity. DIP Onboarding will include the registering of PKI Officers in the Globalsign solution, requesting / receiving PKI certificates and registration of webhooks.

Programme Parties will request and install appropriate PKI certificates. The DIP Provider will install PKI certificates as appropriate.

11.3.1.2 Registering Webhooks

Programme Participants will register the appropriate webhooks.

11.3.1.3 Sending / Receiving a DIP message

Programme Participants from Interval 3 onwards are expected to send a message to the DIP and receive a response. Processing of the message is not required. The exact IF message is left to the discretion of the Programme Participant. This final step in External Connectivity Proving will provide additional confidence. The MHHS Programme acknowledges that this additional requirement has been introduced close to the Connectivity Proving phase but as no development is required we would anticipate minimal impact to Programme Participants.

Market Roles such as EES that are only recipients of DIP messages will not be required to send a message to the DIP as part of External Connectivity Proving.

11.3.2 Internal Connectivity

Programme Participants need to ensure the end to end connectivity of their test environments in order that when CIT test execution commences the Programme Participant knows that they have a functioning test environment.

11.4 SIT Functional Test Connectivity Proving

SIT Functional Testing will test the end to end MHHS solution. Consequently integrated end to end test environment connectivity is required. The nature and scope of SIT Functional Test Connectivity Proving will be included in future versions of this document.

11.5 Environment Availability Requirements

Table 4, below states when each environment is required from the Central Parties. It should be noted that these dates do not include the environment set-up times for Programme Participants. Programme Participants should ensure that all of the activities that they require to source, configure and test their environments are completed prior to the dates stated below. The dates are aligned to the start of the respective test phases. The iterative nature of CIT onboarding will result in some CIT Participants making their environments available slightly later than stated in the table below.

The environment requirements for non-SIT LDSO Qualification testing are not understood at this time. It is anticipated that clarity will be provided in the next version of this document.

Environment	Required from	Required to	Sandbox end
SIT-A	4-Sep-23	04-Apr-25	
SIT Staging	2-Jan-24	19-Jan-26	
SIT-B	1-Apr-24	4-Apr-25	
UIT (Qualification / Sandbox)	09-Sep-24	19-Jan-26	19-Jan-26

Table 4 - Environment Availability Requirements

12 Test Execution

12.1 Planning

SI Test Team will advise Test Participants when SIT and UIT environments can be accessed, to avoid any clashes. For example, there may be different types of tests that need to be performed or conflicts with data and configuration or ensuring only approved code versions are on environments. There may be instances where re-tests will have to be scheduled. The schedules will be defined by the SI Test Workstream Leads and based on the timeframes; slots will be embedded into the environment usage schedules. This section aims to clarify the process around planning. Also, note that Test Participants will need to have their own environments ready according to the schedules.

The programme is intending to allow the placing of reliance on testing performed by third parties as it is pragmatic, helpful to Test Participants and their service providers and entails little risk. Please refer to [REF-09] Placing Reliance Policy.

12.1.1 Tracking and Coordination

- The MHHS Environment Manager is central to all coordination, communication, and escalation.
- EWG will have a regular meeting scheduled on the first Tuesday of every month. This will be chaired by the MHHS Environment Manager. Test Participant Environment Managers or appropriate representatives are encouraged to attend as this will be particularly important during both prep and execution of SIT and UIT phases. Programme test leads and representatives from the design groups are also invited to attend.
- As the project progresses, there may be a need for more frequent meetings covering issues or testing progress. Only interested parties need attend these meetings or 'catch-ups'.
- The MHHS Environment Manager will produce a high-level testing and readiness report at regular intervals. Most likely, these will be weekly, but could increase in frequency based on activity.
- Any scheduling of test phases will be shared via a centralised Gantt chart (or similar) which will be visible to the EWG, and other interested parties published via the MHHS collaboration base.
- A Release Management Plan and Schedule will be published to inform when fix versions will be applied to environments. This will be published on the MHHS collaboration base.
- Azure Dev Ops (ADO) will be utilised to capture testing issues. Environment issues will have its own category and will be triaged as part of the defect workflow. Environment issues will be coordinated by the MHHS Environment Manager. For clarification, the defect workflow is captured in the [REF-05] MHHS-DEL46 Defect Management Plan.

12.1.2 SIT

- Environment Issues 'defects' will also be captured and reviewed so that they do not occur in UIT, and where appropriate will also be flagged for BAU awareness. Environment downtime will also be logged for historical review and future mitigation.
- Test Participants *may* be given timed slots to perform their testing. The SI Test Team and MHHS Test Environment Manager will be responsible for coordination and provision of the test environments which will be communicated to Test Participants. Test Participants will be responsible for provision of their own test environments and will need to coordinate with the MHHS Environment manager to connect to central systems.

12.1.3 UIT

- **Qualification** will have a tranche system where Test Participants will be allocated to tranches by the Code Bodies in order to perform their testing. The SI Test Team and MHHS Test Environment Manager will be responsible for coordination and provision of the core capability providers test environments which will be communicated to Test Participants. Qualification Test Participants will be responsible for provision of their own test environments and will need to coordinate with the MHHS Environment manager to connect to central systems. Please refer to [REF08] MHHS-DEL1118 Qualification Approach & Plan for details regarding Qualification.
- **E2E Sandbox** is an optional phase but *may* need a level of coordination which will be confirmed at a later date. The SI Test Team, MHHS Test Environment Manager and Code Bodies will be accountable for coordination of the central test environments which will be communicated to Test Participants. Test Participants will be responsible for provision of their own test environments and will need to coordinate with the MHHS Environment manager to connect to central systems.

12.2 Assurance and Readiness Criteria

Various techniques and processes will be put in place to ensure central system environments are ready for use. As system design progresses more detailed information will be added to this section. Assurance and readiness can be separated into two different methods: Pre-testing cycle readiness and Testing cycle readiness.

- Pre-testing – before a testing phase commences, environments need to be functional from day one. The SI Test Team will ensure that environments are prepped and ready for testing. Therefore, certain assurances need to be given to ensure environment readiness:
 - Test Participants will be expected to fulfil SIT and UIT entry criteria. Entry criteria relating to environment requirements will be specified in relevant test planning documentation when available.
 - The programme will inform Test Participants when testing starts. Information will be communicated by the SI Test Team.
 - Necessary user access arranged by the SI Test Team to connect and log into systems. The process to do this is documented on the [REF-06] MHHS DIP 094 Interface Code of Connection.
 - Environment Proving tests to be executed by relevant parties where systems are directly or indirectly part of the test cycle. For example, if an application or system is being tested then that is considered as direct involvement. If a system isn't under test, but is need for endpoint checks, then that is considered as indirect involvement. These tests will be specified by the SI Test Team and will confirm the following:
 - Network connectivity tests – simple ping (subject to security requirements) and DNS tests to ensure the network is up and running and endpoints are available.
 - Certificates check – ensuring correct certificates are setup. Different test environments will need different certificates e.g., SIT A will have its own, UIT its own, etc. Hence, each environment will need its own certificate check. Please refer to the Code of Connection for details regarding PKI certificates and DIP Onboarding, in [REF-06] MHHS DIP 094 Interface Code of Connection.
 - Test data verification – simple checks to verify correct data is available in the system.
 - Environment monitoring and alerts in place (covered in the Monitoring section).
 - SI Test Team will confirm readiness through formal procedures (format tbc).
 - Testing Cycles – during daily testing cycles, a level of confidence should be given to ensure the test environments are fit for purpose. To mitigate this, the following will be put into place (depending on system design):
 - Daily morning status health check reports for central systems. Depending on system design, these can be manual or automated.
 - Live environment monitoring and alerts in place (covered in the Monitoring section)

- Test Participants are also encouraged to give updates on their own environment readiness and health status.
- Different tests phases will not be run on the same environment and will help to ensure approved release versions are being tested.

12.3 Communications and Meetings

12.3.1 Mail and Mail Groups

- As the Programme proceeds a separate mailbox *may* be created for environment queries and mailings.
- As the Programme proceeds an MS Teams channel *may* be setup to service immediate queries.

12.3.2 Meetings

- Testing cycle – as participants enter SIT and UIT phases, more focused meetings may be necessary to cover the state of the environments in relation to the testing. The meeting may be in the form of a sole environment meeting or embedded into a main testing catch-up.
- Issues – issues will be raised via the defect management workflow process. When issues are triaged and identified as environment issues, they will then be tracked by the MHHS Environment Manager. Separate meetings may be needed to track and resolve issues. These meetings are likely to be short 'stand-ups' via Microsoft Teams where parties involved in testing and resolution will be invited. Defects identified as environment issues will be filtered and shared via an ADO dashboard with action points captured and shared via minutes. Subsequent meetings will follow up the action points.

12.4 Monitoring

12.4.1 Manual Monitoring

Any issues that hinder testing will impact not only the individual Core System Provider but all other parties participating in testing. In the absence of an automated monitoring solution Core System Test Participants must ensure that there is robust monitoring of their test architecture and any issues raised as 'defects' in ADO and any issues highlighted to the MHHS Environments Manager.

12.5 Availability

To meet tight testing deadlines, effective environment management needs to be in place to ensure environments are ready and functioning appropriately before and during the testing phase. The aim is to minimise downtime so that environments are available. Environments may not be available for either planned or unplanned periods. In addition, certain assurances and readiness criteria can mitigate against any environment downtime (covered in detail under the Assurance and Readiness Criteria section). Whilst the exact mechanism for informing Programme Participants of any environment outages is yet to be determined it is likely to be via email, although other mediums may be used.

12.5.1 Central Systems Unavailability

Although the aim is to minimise downtime, environments may not be available for either planned or unplanned periods. Central Systems will provide details of planned or regular schedules when environments are not available. Where appropriate, SLAs will be collated. When this information is available, it will be documented in the ADO Test Management Tool.

- Reasons for unplanned environment unavailability:
 - Infrastructure failures – these can be (but not limited to) servers being down, memory bottlenecks, connection failures, network errors.
 - Software failures – severe defects, deployment failures, security failures.

If an unplanned issue occurs a defect should be raised as per the defect management process where they will be triaged and tracked. It is incumbent on Test Participants to highlight any issues. If the incident is critical i.e., a blocker, then this should be escalated to the MHHS Defect and Environment managers. Environment defects will try to be resolved as soon as possible and regular updates will be communicated. The Defect Management process is documented in [REF-05] MHHS-DEL466 Defect Management Plan.

- Reasons for planned environment unavailability:
 - Data refreshes
 - Data Loads
 - Infrastructure maintenance
 - Infrastructure patching
 - Code deployments.

Where planned environment outages may occur on central systems, the MHHS Environment Manager will communicate this to the EWG and other Test Participants in advance and will be added to the testing schedule. There may be situations where an adhoc outage occurs and hence maintenance may need to be planned. This can usually happen when a serious issue on the environment needs to be fixed. Whilst the exact mechanism for informing Programme Participants of any environment outages is yet to be determined it is likely to be via email, although other mediums may be used.

12.5.2 Test Participant Systems Unavailability

Test Participant systems will need to be connected to central systems during relevant phases for SIT and UIT. During the testing phase, Test Participants will need to advise the SI Test Team of any outages. Early communication is important as testing could be impacted, not only to the applications being tested, but also where there is a dependency on the application(s). Planned non-availability will be captured on logs. However, unplanned incidents should be raised initially as defects by the individual/team encountering the problem and will follow the defect triage process as specified on [REF-05] MHHS-DEL46 Defect Management Plan. The incident should also be communicated via email and Teams channels, as soon as possible, quoting the defect number.

It will not be SI responsibility to ensure availability of Test Participant systems, however, if an incident occurs, the MHHS Environment Manager will be the central point to ensure the correct parties are involved in resolving the issues.

12.5.3 Unavailability and mitigation

When an unplanned environment outage occurs, it may have an impact on original testing timelines. In such circumstances, Test Participants will need to liaise with the SI Test Team on the impact and discuss any re-plans. The SI Test Team will then need to work with the TMAG to negotiate and mitigate any impact on test completion and sign offs.

Tracking environment downtime will help pinpoint root causes. An Environment Outage tracker will be utilised in order to track environment downtime. The exact mechanism is under discussion and will be defined prior to the commencement of CIT.

12.6 Maintenance

Test environments will most likely need periods of maintenance and hence there could be specific times when an environment is not available. These periods will be scheduled into the planning and testing timeframes will work around them or vice versa. Maintenance may be scheduled for the following reasons:

- Data refreshes – test data in environments can become messy. There will not be any regular data refresh slots. However, in some cases data refreshes may be needed to avoid bad data and data conflicts. Test Participants should advise in advance when data refreshes will happen to avoid data going out of sync with other testing activities. Ideally, this will fall into line with planned environment unavailability.
- Data loads – certain types of data may need to be loaded or reloaded for different parties or types of testing. Method of a data load may affect the maintenance period. For example, a data injection may not be a huge effort, but sometimes data may need to flow through the system as there may be data dependencies.
- General Maintenance – Infrastructure may need general maintenance such as server reboots, replacement of hardware, routine upgrades, infrastructure patches, etc. Occasionally, there may be unforeseen circumstances where general maintenance is required.
- Rollbacks – time may be required to perform system rollbacks. Circumstances where this may occur could be to rollback code versions or return a system to its prior state before an outage. It is unlikely that a rollback will be required, and if so is likely to follow immediately following a release deployment and therefore prior to any significant (if any) testing activity having taken place. In the event of issues impacting a release deployment it is more likely that parties will ‘fix forward’.

12.7.1 DIP

Activity	Notes
Environment availability	Weekday. 0900 to 1700.
Monitoring	DIP L1 Support Team will monitor and inform MHHS as required.
Back-ups	Periodic, every 4 hours. Retention period – 7 days.
Other	

Table 5 - DIP Environment Availability, Monitoring and Back ups

12.7.2 Elexon (Helix)

Activity	Notes
Environment availability	Environment operability – 24/7. Support, weekday 0900 to 1700.
Monitoring	Internal monitoring and alerts. In the event of failure MHHS will be informed.
Back-ups	TBC
Other	

Table 6 - Elexon (Helix) Environment Availability, Monitoring and Back ups

12.7.3 Recco

Activity	Notes
Environment availability	Environment operability – 24/7. Support – standard weekday business hours 0800 to 1800.
Monitoring	Internal monitoring and alerts. In the event of failure MHHS will be informed.
Back-ups	Data cut taken, augmented and backed up prior to the start of test execution. No periodic back-ups during test execution.
Other	

Table 7 - Recco Environment Availability, Monitoring and Back ups

12.7.4 St. Clements

Activity	Notes
Environment availability	Week day working day, 0900 to 1700.
Monitoring	St. Clements will monitor environments and inform MHHS of any outages.
Back-ups	Weekly.
Other	Gate Closure – 15:00 End of Day Batch – 15:15

Table 8 - St. Clements Environment Availability, Monitoring and Back ups

12.7.5 DCC

Activity	Notes
Environment availability	In discussion with DCC
Monitoring	In discussion with DCC
Back-ups	In discussion with DCC
Other	In discussion with DCC

Table 9 - DCC Environment Availability, Monitoring and Back-ups

12.8 Programme Participants Data Back-ups

12.8.1 Frequency and timing of Data Back-up

For SIT Functional Testing (not SIT Component Integration Testing) Programme Participants are encouraged to back up their test data weekly, preferably at midnight on a Saturday. It is acknowledged that each participant will have different back-up schedules that they may differ to midnight Saturday. A back-up close to this time is not considered to be problematic.

12.8.2 Nature of Back-up

Back-ups should be rolling back-ups, i.e. each back-up replaces the previous back-up.

12.8.3 Restore from Back-up

Programme Participants are encouraged to test that they can restore from a back-up prior to the commencement of CIT Execution.

13 Roles and Responsibilities

This section will highlight the involved actors associated with the approach. It mainly consists of EWG members formed from the SI, SRO, TPs, and PPC/PMO functions.

13.1 Environment Managers

- The MHHS Environment Manager is the central point for coordination
 - Chair EWG meetings and any other ongoing meetings relating to test environments.
 - Act as the central contact or liaison point for environment issues, readiness, planning, communication.
 - Point of escalation for matters relating to test environments.
- Test Participants are expected to have their own Environment Manager or representative
 - Environment managers or representatives will be identified by relevant parties and captured centrally in the programme database as a point of contact.
 - Attend EWG meetings. For certain areas, there may be one representative for multiple systems.
 - Act as the central contact or liaison point for their own systems.
 - Point of escalation for matters relating to their own test environments.
 - Participate in any additional functions or meetings relating to environments.

13.2 Programme Responsibilities

Error! Reference source not found.describes the roles of those participating in the MHHS Programme environment duties:

Role	Description
MHHS Environment Manager (SI)	<ul style="list-style-type: none">• Coordination for planning and maintaining schedule for test environment usage.• Documenting the environment provision plan with the SI Test Team when available.• Raising and/or coordinating any environment Defect in ADO and liaising with relevant environment teams.• Assuring environments are stable during the Test window in conjunction with the relevant environment managers.• Managing & Tracking change in general across all environments.• Involved in Defect Triage meetings on a regular basis.• Assuring that all required systems are connected & working as expected in the test environment prior to test execution.
TPs Environment Managers	<ul style="list-style-type: none">• Point of contact for their own test environments.• Timely provision of their own test environments.• Participating in environment meetings.• Raising environment defects for their own systems (if they impact the MHHS Programme in ADO and liaising with relevant environment teams.• Responsible for environment defects that their own systems have an impact on.
SI Defect Manager	<ul style="list-style-type: none">• Leadership & communication of Defect management process.• Point of Escalation for defect issues and defect SLAs.• Regular Defect Status Reporting.• Running Defect Triage Panel and managing the audience.

Role	Description
	<ul style="list-style-type: none"> • Analysis of Defects to assist in project decision-making activities. • Liaising upstream with senior stakeholders and downstream with Test Participants Test and Programme teams. • Single point of contact for any user level access management towards Defect Management Tool (ADO). • Involved in Defect status calls / Triage meetings.
SI Triage Team	<ul style="list-style-type: none"> • Representation from SI Design, Test and Programme teams. • Review and analyse the newly raised Defects (along with Severity and Priority of the Defect) by different Test Participants' Test team and drive relevant actions. • Change the assigned Priority and Severity if required as a part of triage assessment. • Involved in regular Defect Triage Meetings. • Involved in changing the status from 'New' to 'Open' if a newly raised Defect is accepted by SI Triage Team.
Test Defect Manager (per Test Participant)	<ul style="list-style-type: none"> • Reviewing & managing the quality of the Defect Submitted by Tester (along with Severity and Priority of the Defect). • Involved in Defect Triage meetings on a regular basis. • Point of contact for the SI Defect Manager and Test Execution Team. • Driving Retest of Defects that have been delivered into the test environment. • Reviewing, accepting, and closing Defects that have been successfully retested in the test environment.
SI Release Manager	<ul style="list-style-type: none"> • Responsible for release management plan. • Checking Release Notes when patch is delivered to determine which Defects can be set to retest. • Coordinating with the SI Defect & environment managers when required.
Tester (Test Participant)	<ul style="list-style-type: none"> • Submitting new Defects. • Defect retest. • Involved in Defect Triage meetings on a regular basis wherever necessary. • Retesting fixed Defects as per the release notes/info in Defect Management Tool (ADO).
SI Design Authority	<ul style="list-style-type: none"> • Provides Design concurrence for the design activities under the MHHS solution for environments.
SRO TMAG Chair	<ul style="list-style-type: none"> • Point of escalation for System Integrator. • Oversight of Environment Management process.
BSC and/or RECCO	<ul style="list-style-type: none"> • Point of escalation for System Integrator during Qualification.
PMO	<ul style="list-style-type: none"> • Set up and highlight agenda for monthly EWG meetings. • General communication and escalation point. • Administering documentation.
Security Points of Contact	<ul style="list-style-type: none"> • Responsible as central points of contact for obtaining certificates and any other information related certificates. • Roles are defined in [REF-06] MHHS DIP 094 Interface Code of Connection Guide include DIP Service Providers

Role	Description
DIP Representatives	<ul style="list-style-type: none"> • Responsible for certificate registration • Roles are defined in [REF-06] MHHS DIP 094 Interface Code of Connection Guide include Senior Responsible Officer (SRO), Appointed Responsible Officer (ARO) and Technical Contact (TC)

Table 10 - Roles and Responsibilities

14 Content Outstanding

At present not all of the detail regarding environments is known. Content will be added on the following;

- DCC Test Environment architecture.
- DCC Test Environment – shared usage.
- SIT Functional E2E Test Environment architecture and Market Role integration.
- SIT Non-Functional E2E Test Environment architecture.
- Qualification Test Environment architecture.
- Test Environment requirements for Non-SIT LDSO Qualification testing.
- Confirmation that the Qualification (UIT) Environment can support the Sandbox.

Figure 25, below provides a view of how the Environments Approach & Plan will iterate as the knowledge base is enriched. In order for the document to be uplifted for the various test phases there are a number of dependencies that need to be satisfied.

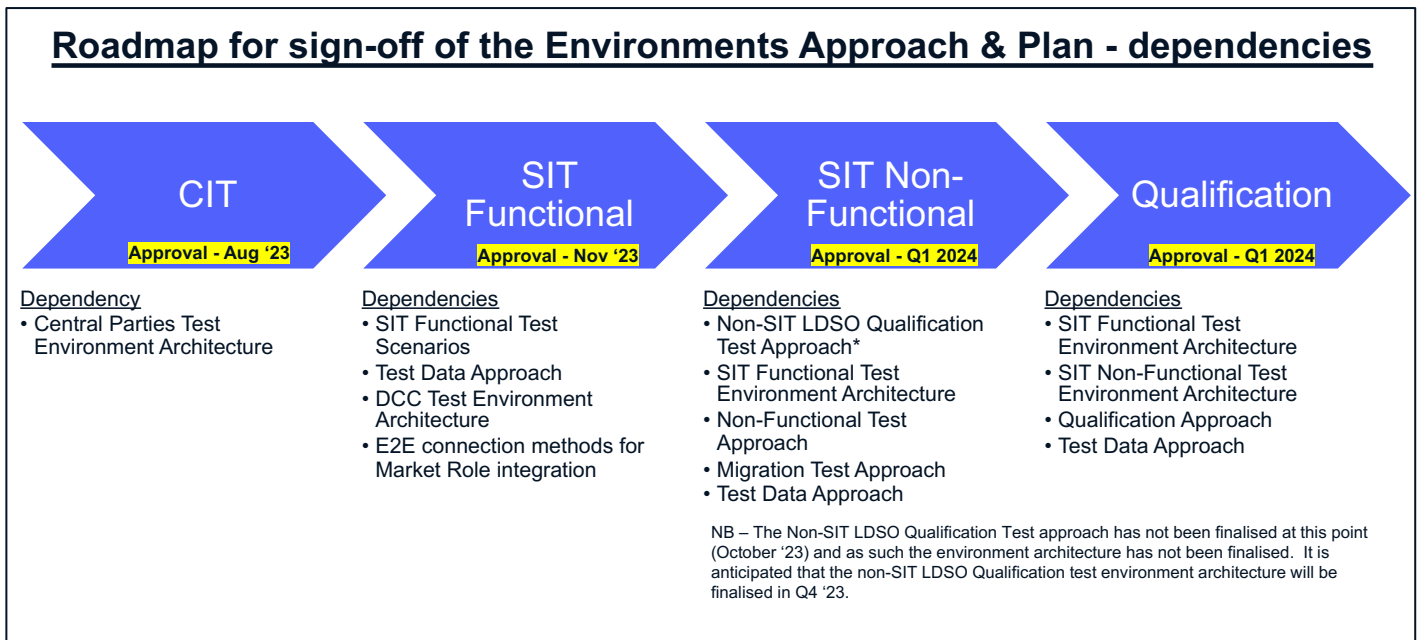

Figure 25 - Roadmap for sign-off of the Environments Approach & Plan - dependencies